

# Development of High Temperature/High Sensitivity Novel Chemical Resistive Sensor

**PhD Students:** Erik Enriquez, Shanyong Bao, & Brennan Mace

**PhD Awarded:** Dr. Chunrui Ma (UK) & Dr. Gregory Collins (WVU)

**PIs:** Patrick Nash (retired 2012) and Chonglin Chen (PI)

Department of Physics and Astronomy, University of Texas at San Antonio, San Antonio, TX 78249-1644

Phone: 210-458-6427, Email: [cl.chen@utsa.edu](mailto:cl.chen@utsa.edu)

Grant Number: DE-FE0003780

Project Manager: Dr. Susan M. Maley

Performance Period: 09/01/2010-8/31/2013

- **Introduction**
- Mixed Ionic/Electronic Conductive  $\text{LnBaCo}_2\text{O}_{5.5}$  Oxides
- Full Scale Chemical Sensor Development
- **Summary**

# OBJECTIVES & GOALS

- **The objective of this research is:**
  - investigate and understand the mechanisms of mixed ionic electronic conductive  $\text{LaBaCo}_2\text{O}_{5+\delta}$  highly epitaxial thin-films
  - establish the relationship between electrochemical properties and surface/interface microstructure of the mixed conductive thin films
  - determine the overall feasibility of the  $\text{LaBaCo}_2\text{O}_{5.5+\delta}$  based novel electrochemical devices for sensing gases in high temperature applications.
- **The goals of this research are:**
  - resolving and optimizing fabrication issues of highly epitaxial  $\text{LaBaCo}_2\text{O}_{5+\delta}$  single crystalline thin films
  - establishing relationship of processing—microstructure—sensing properties—stability of the  $\text{LaBaCo}_2\text{O}_{5+\delta}$  thin film
  - understanding the kinetics and mechanisms of redox processes on the  $\text{LaBaCo}_2\text{O}_{5.5+\delta}$  thin films
  - demonstrating the new concept high temperature, high sensitivity, and chemically stable devices for high temperature applications.

# Why LBCO?

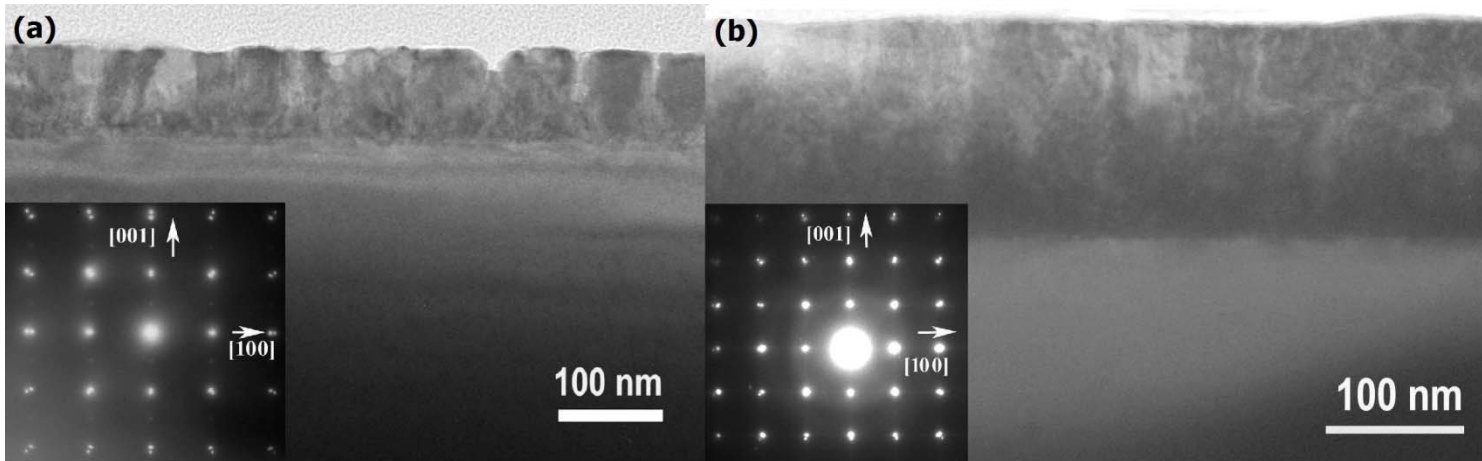
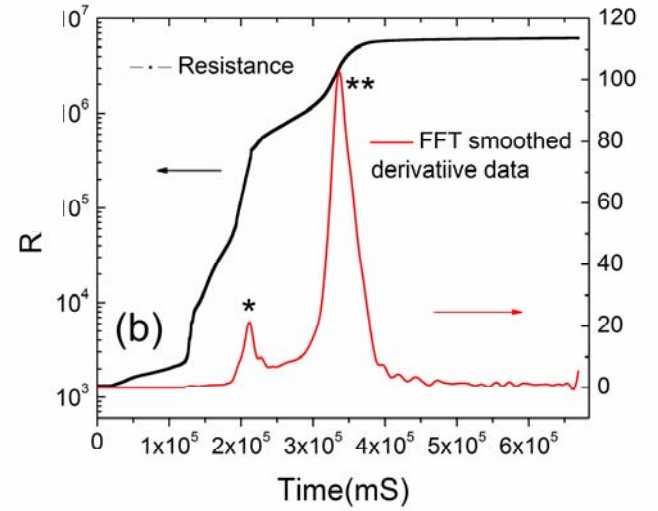
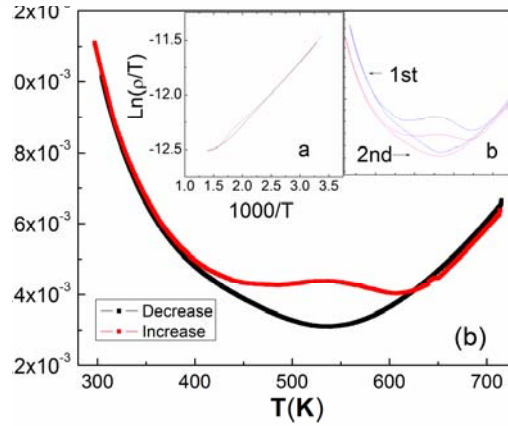
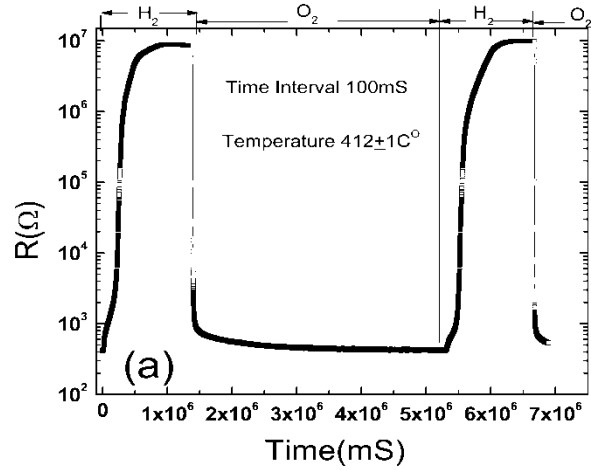
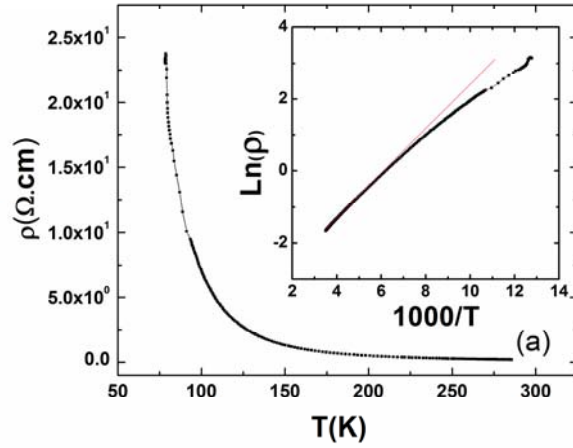
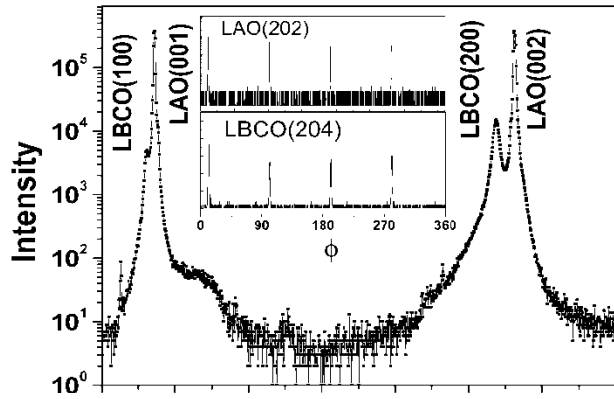

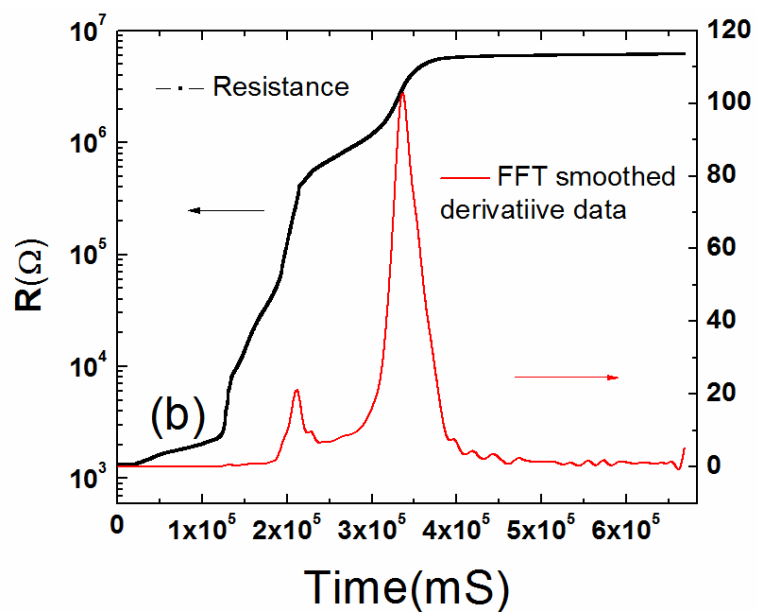
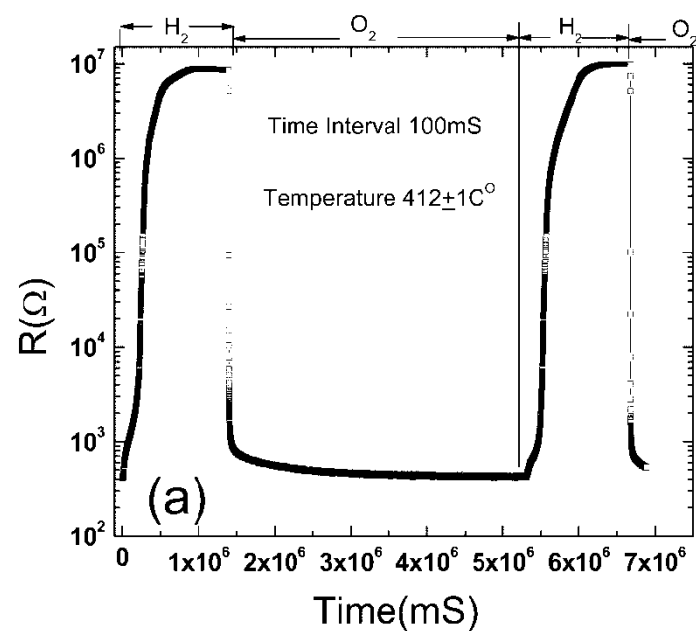

# CHEMISTRY OF MATERIALS

FEBRUARY 9, 2010 VOLUME 22 NUMBER 3 [pubs.acs.org/cm](http://pubs.acs.org/cm)

**SPECIAL ISSUE: MATERIALS CHEMISTRY OF ENERGY CONVERSION**

ACS Publications  
High quality. High impact.

[www.acs.org](http://www.acs.org)

# Nanoscale ordered cobaltite $\text{LaBaCo}_2\text{O}_6$ thin films

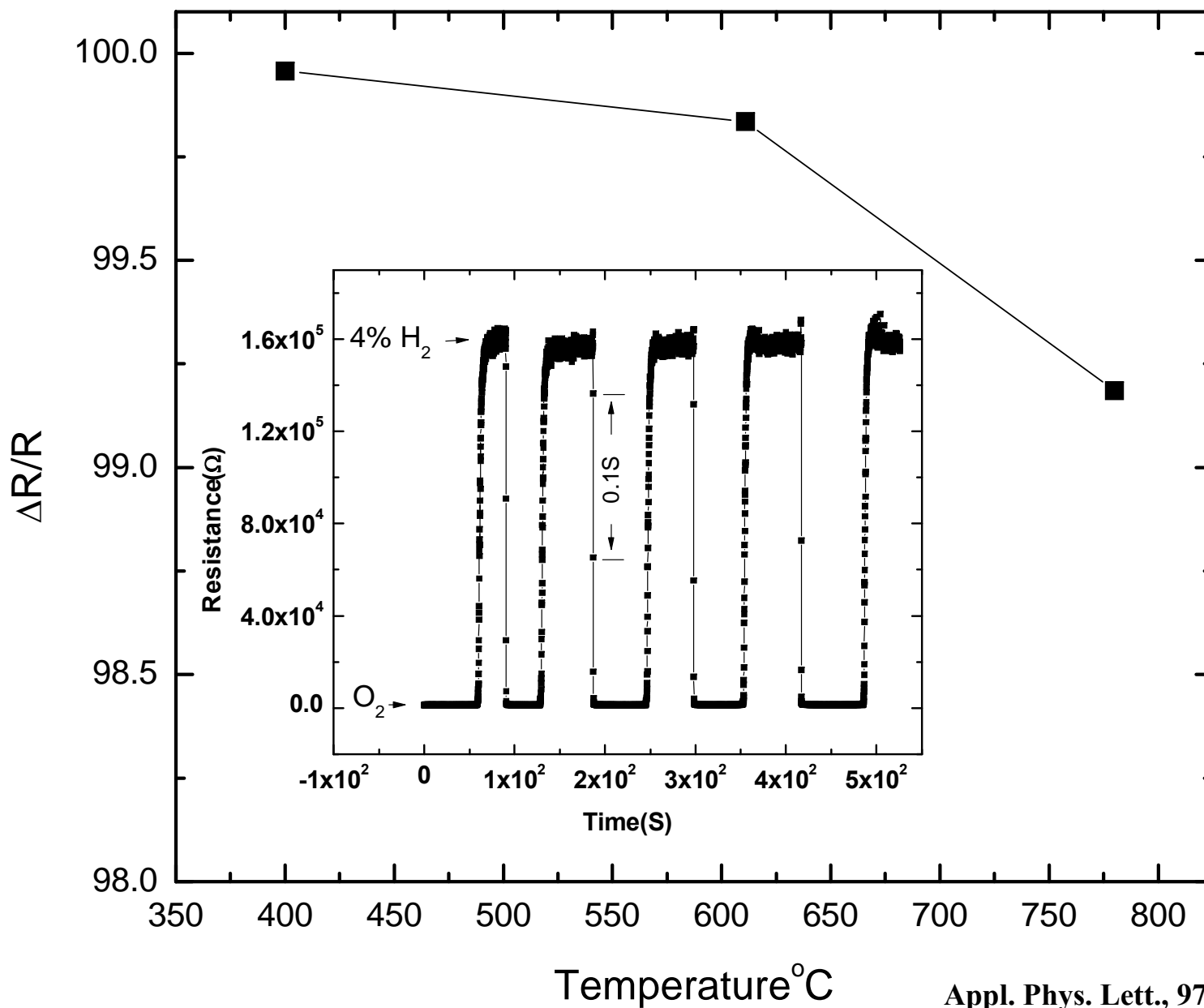

# Sensor Structures

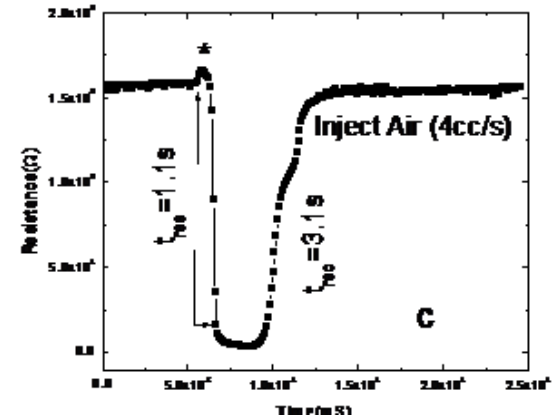
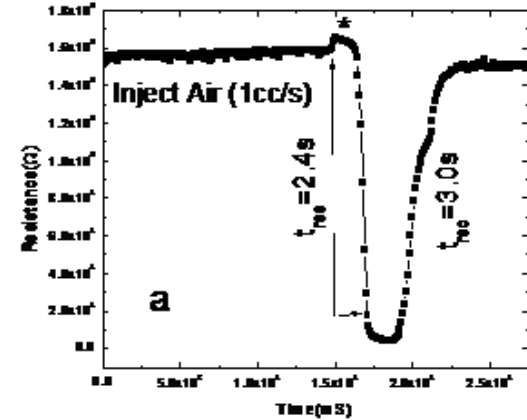
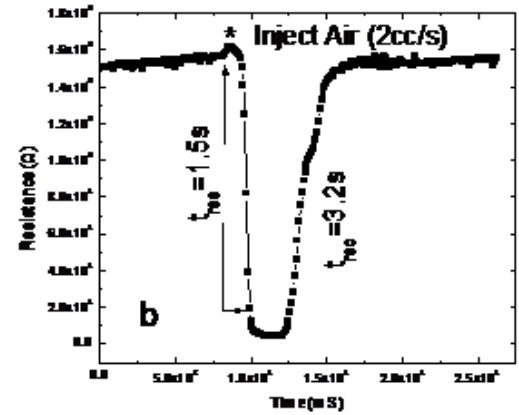
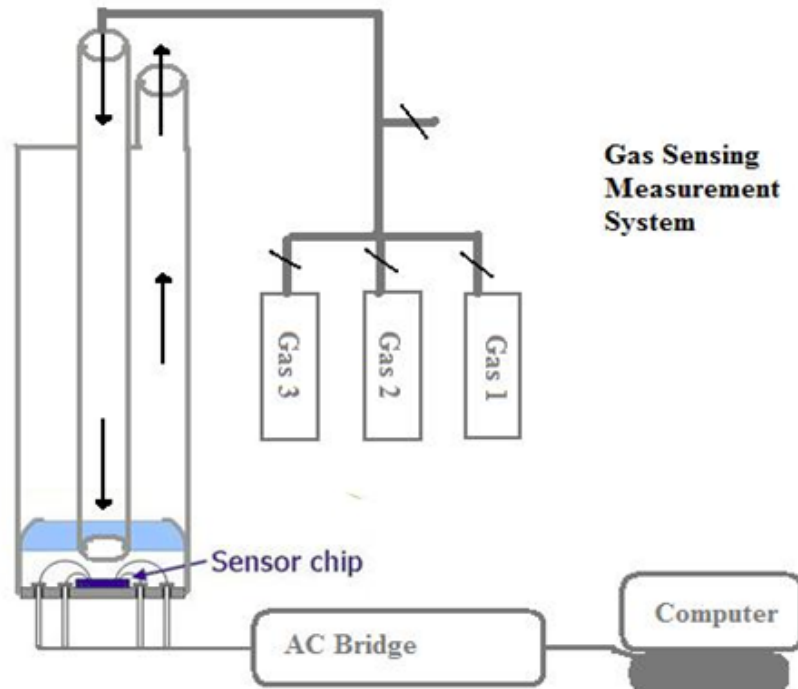
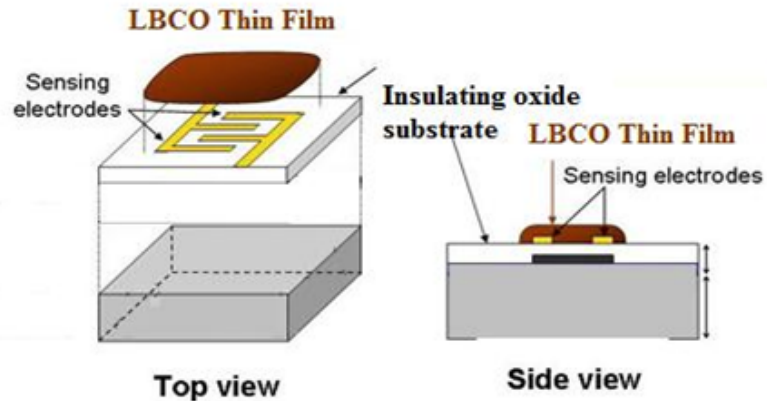

# Oxygen Deficient Double Perovskite (LnBa)Co<sub>2</sub>O<sub>5+δ</sub> (Ln=Lanthanide)

## Structure of LnBaCo<sub>2</sub>O<sub>5+δ</sub>

- — Ba
- — Ln
- — Co
- — O (occupied)
- — O (partial occupied)

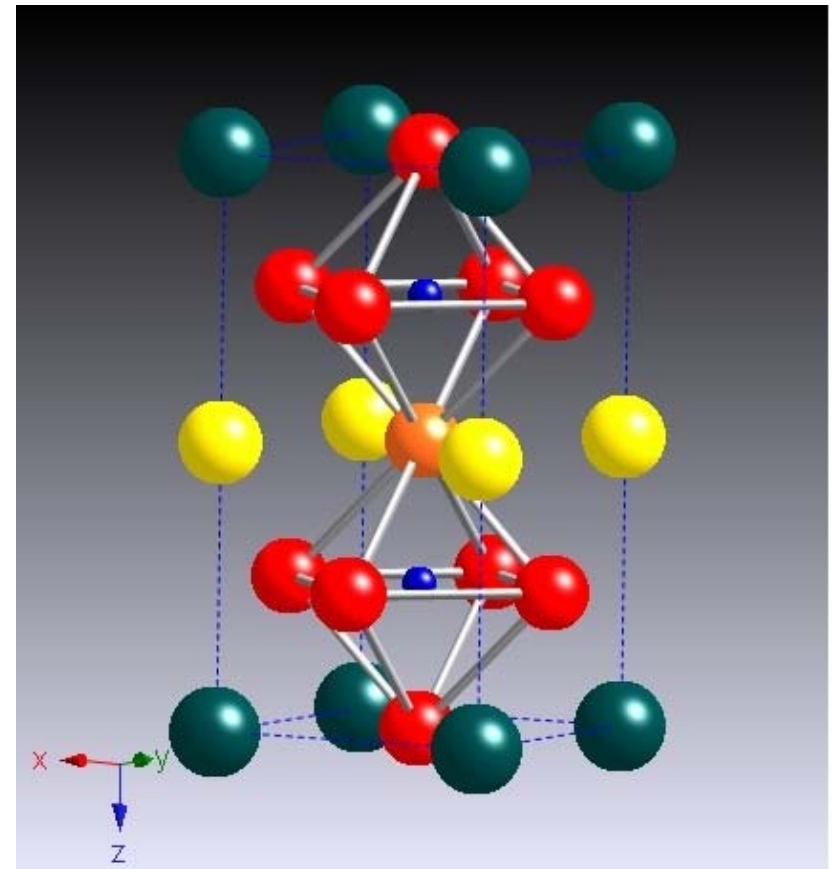

# (La, Ba)Co<sub>2</sub>O<sub>5+δ</sub>

$$Co^{2+} : Co^{3+} = \left( \frac{1}{2} - \delta \right) : \left( \frac{1}{2} + \delta \right) \text{-----} 0 \leq \delta \leq 0.5$$

$$Co^{4+} : Co^{3+} = \left( \delta - \frac{1}{2} \right) : \left( \frac{3}{2} - \delta \right) \text{-----} 1 \geq \delta \geq 0.5$$

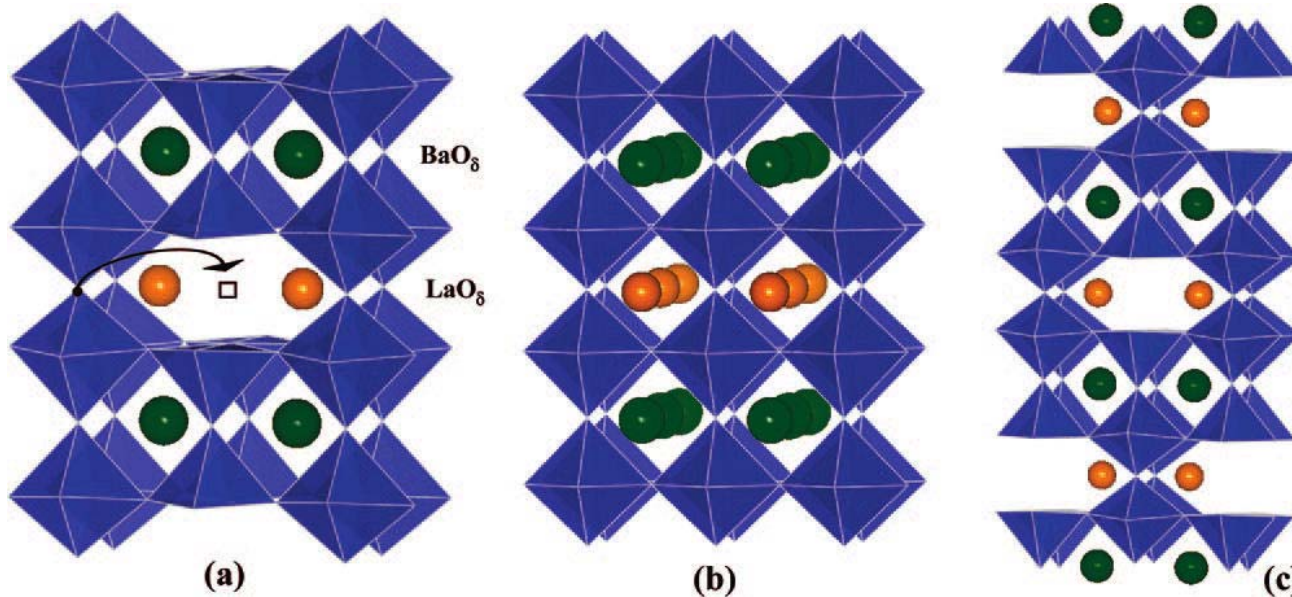



# LaBaCo<sub>2</sub>O<sub>5+δ</sub> Thin Film on (001)LaAlO<sub>3</sub>

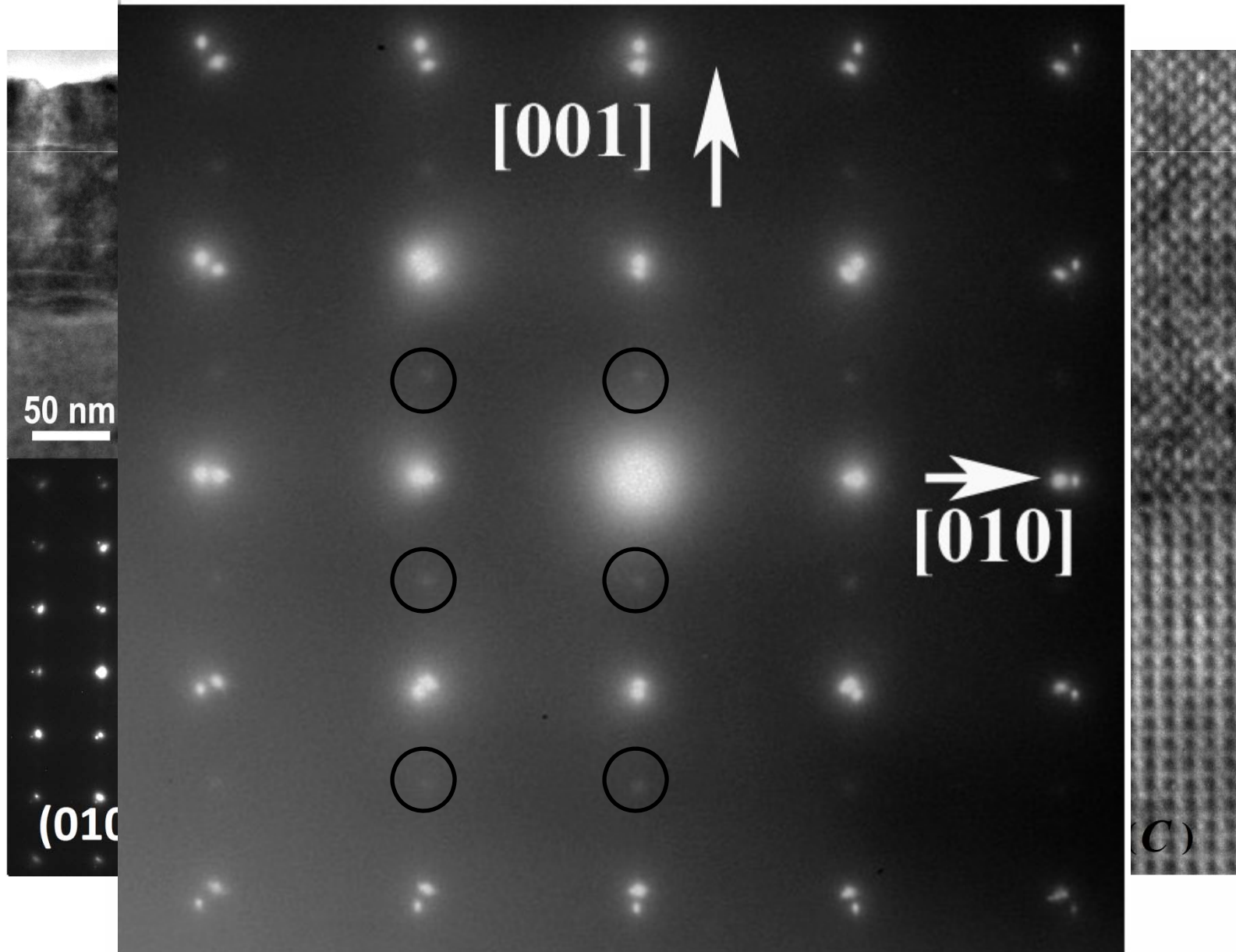

# Transport Properties in 4%H<sub>2</sub> / N<sub>2</sub>

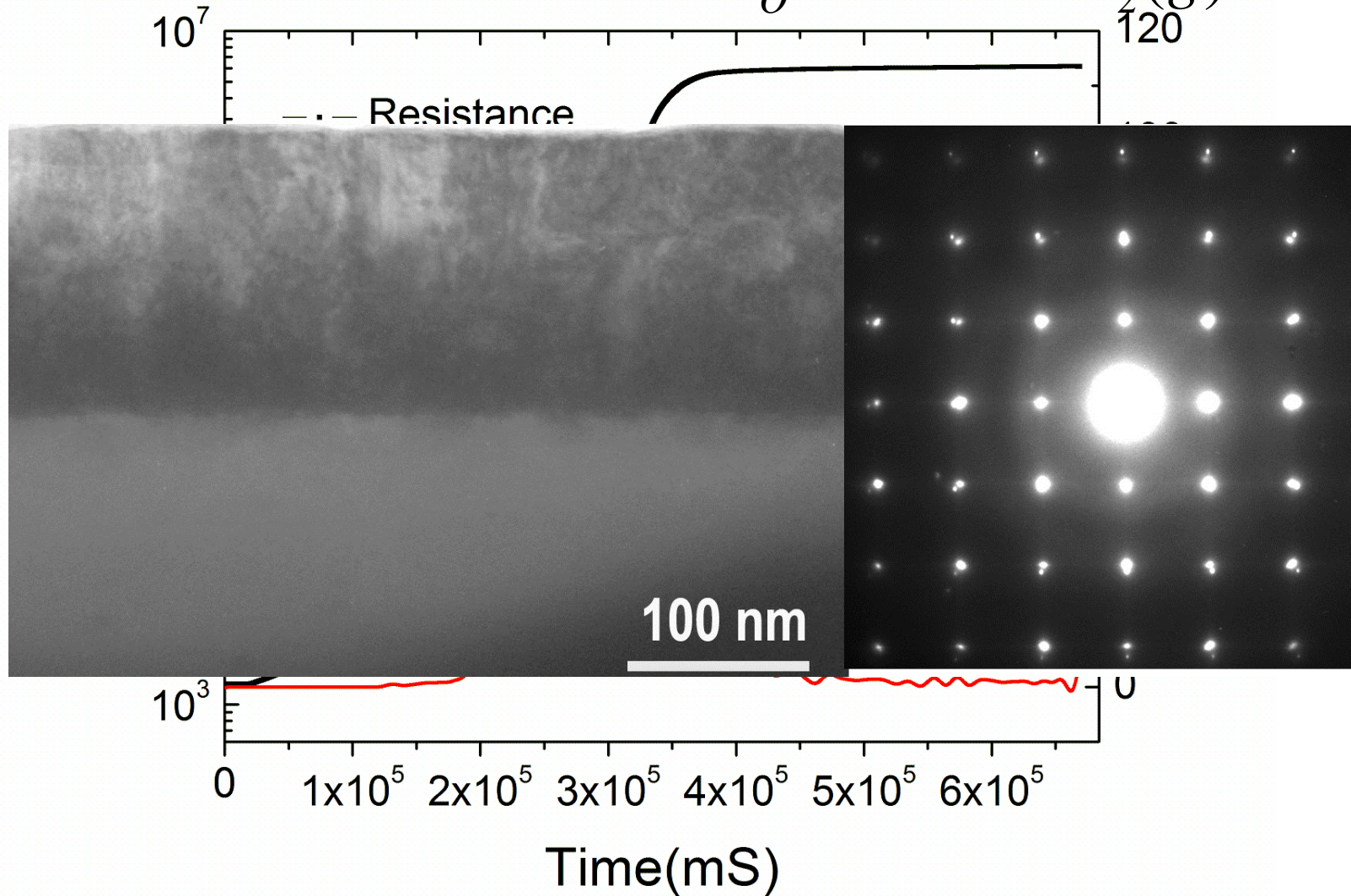
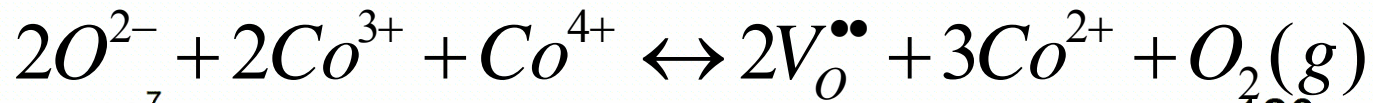

# Transport Properties in O<sub>2</sub>

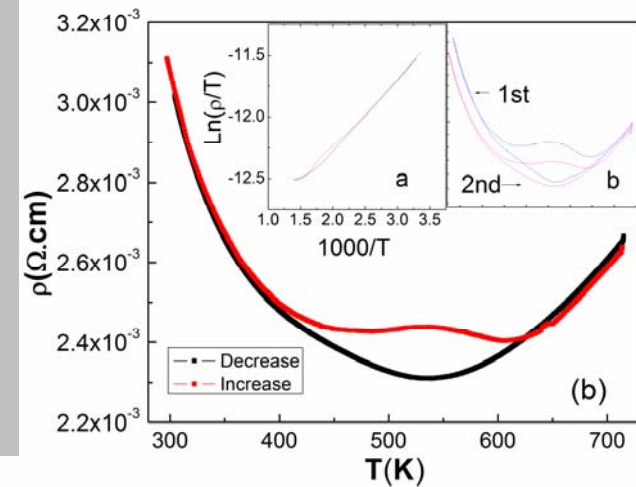
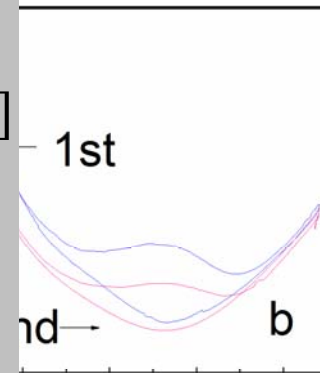
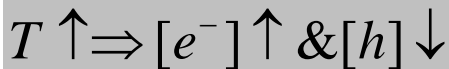
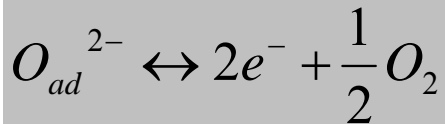
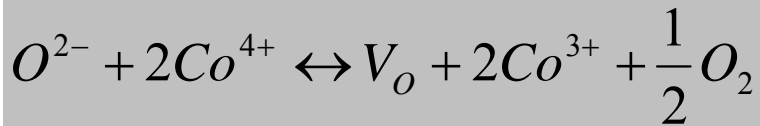
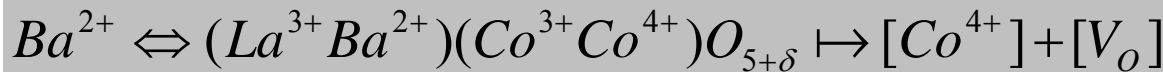

T(K)

# Transport Properties in 4% $H_2$ / $N_2$

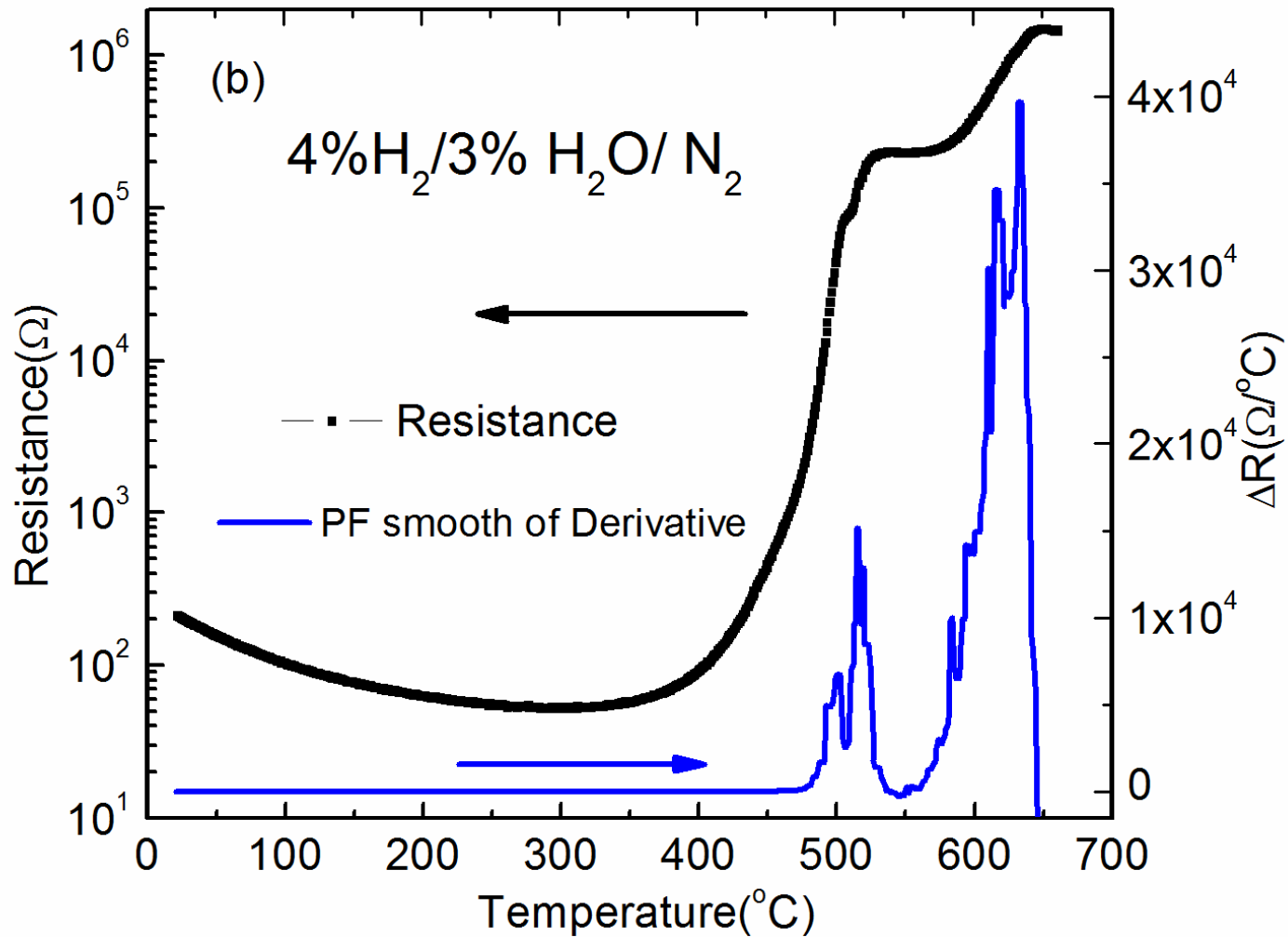

# Nanoscale ordered cobaltite

## LaBaCo<sub>2</sub>O<sub>6</sub>

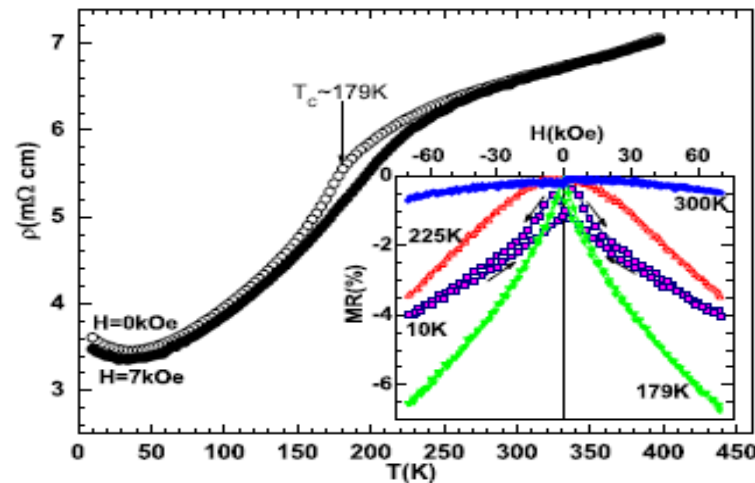
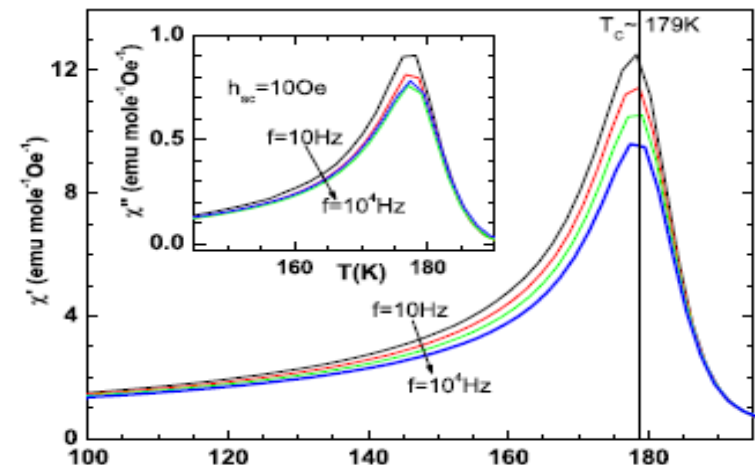
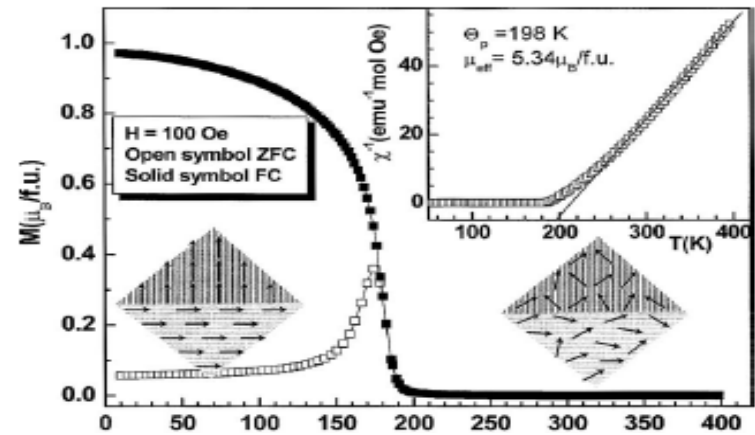
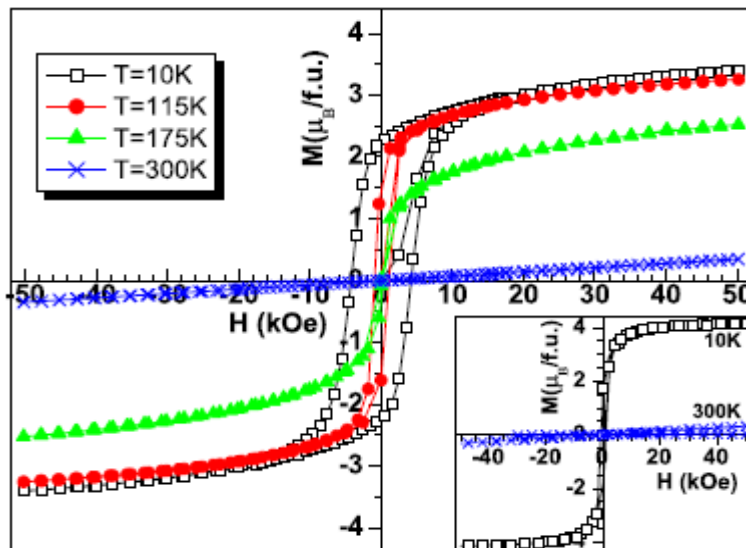
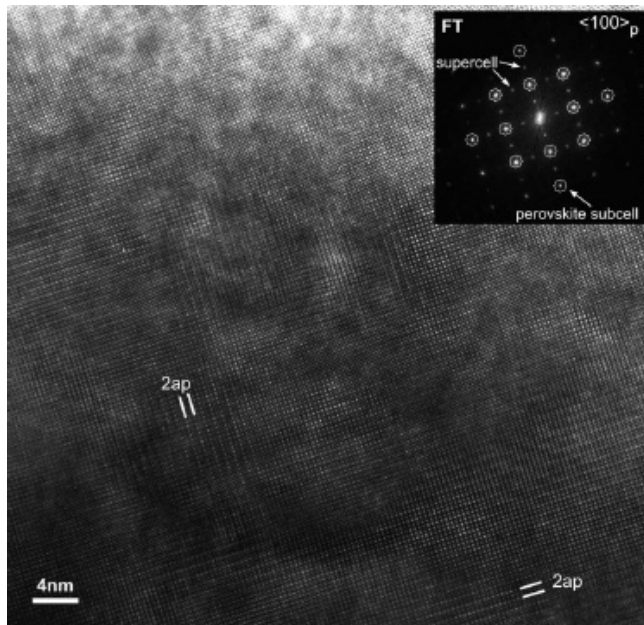

# Nanoscale ordered cobaltite $\text{LaBaCo}_2\text{O}_6$

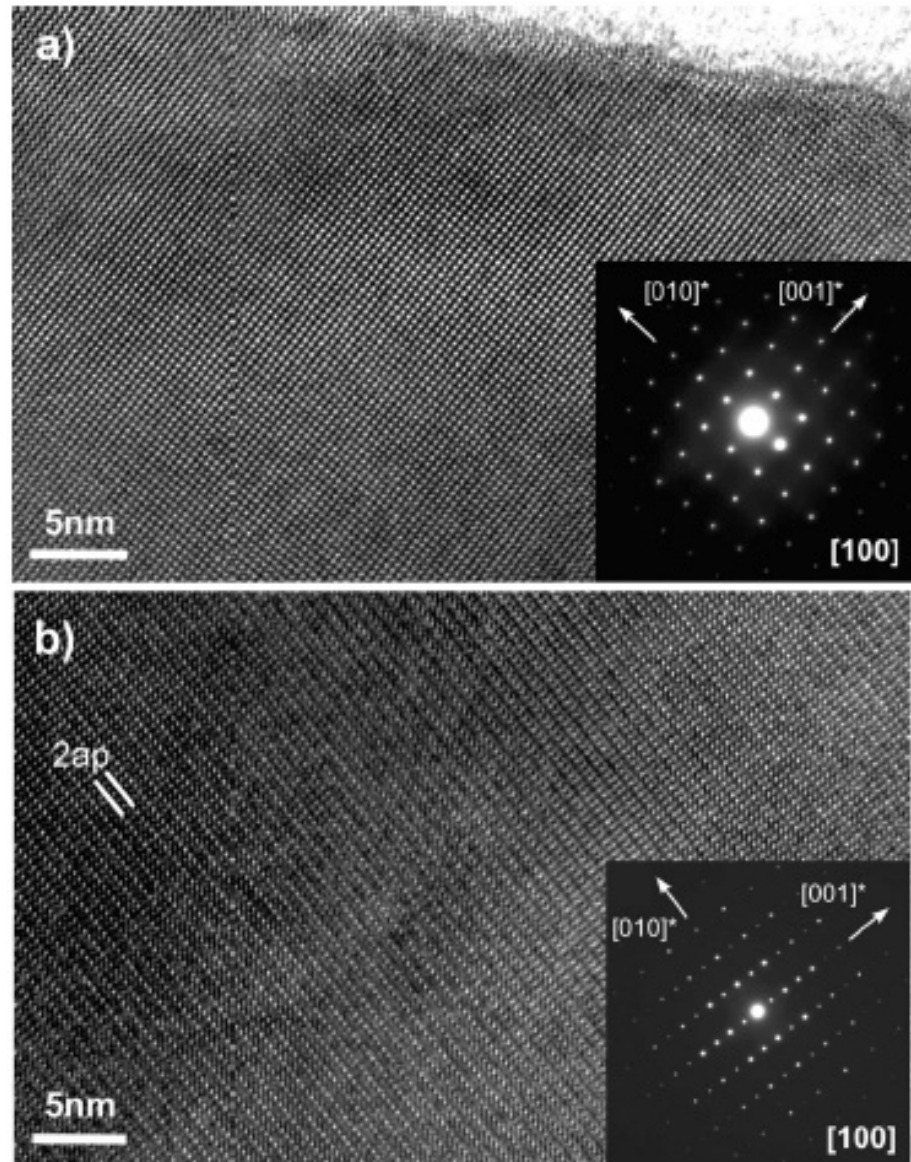
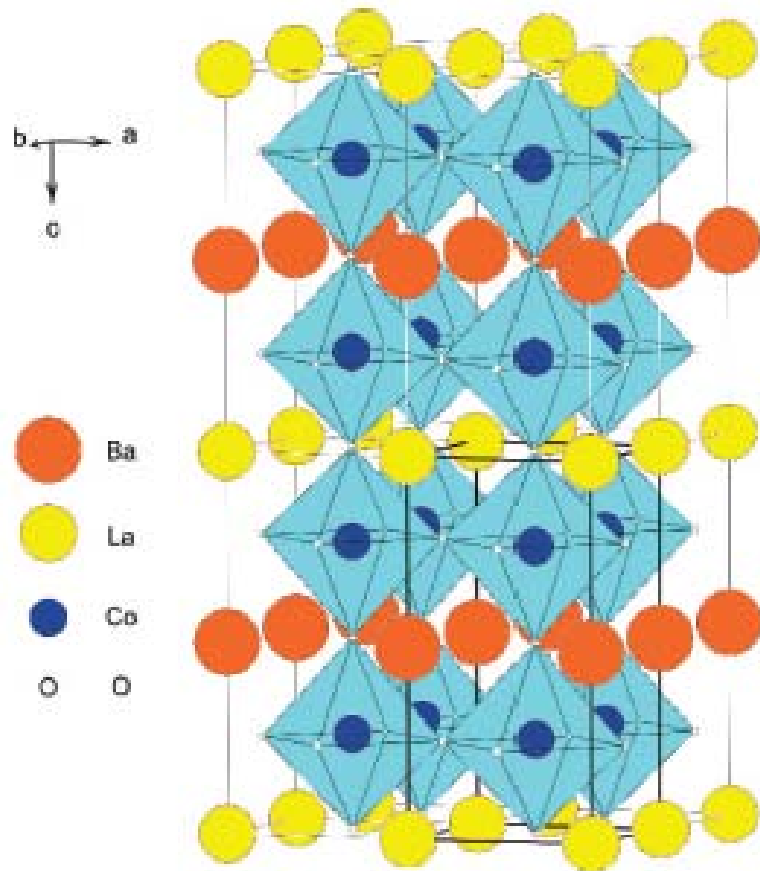

# Nanoscale ordered cobaltite $\text{LaBaCo}_2\text{O}_6$

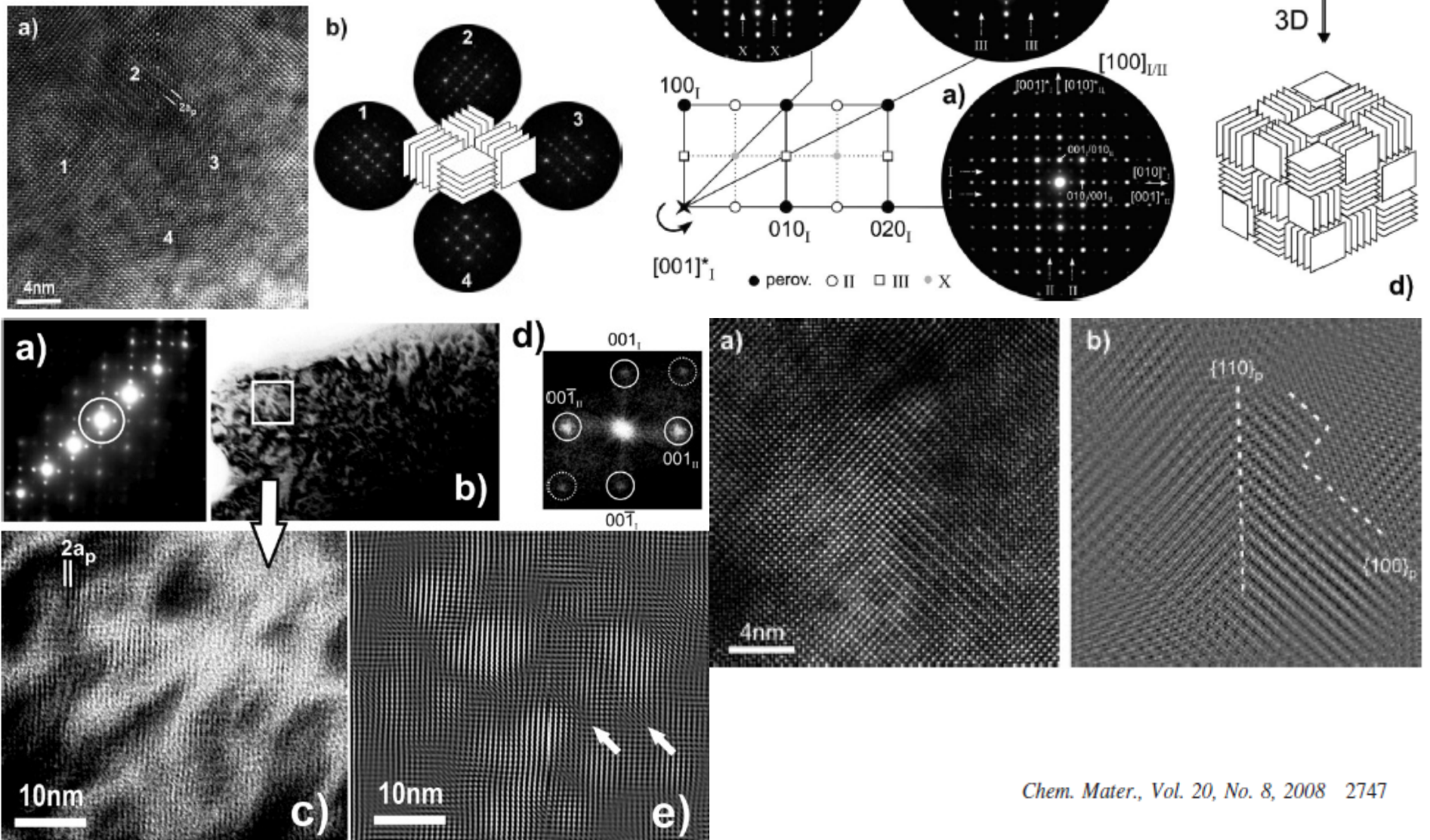

# Physical Properties of cobaltite $\text{LaBaCo}_2\text{O}_6$

Ordering Nano-Ordering Disordering

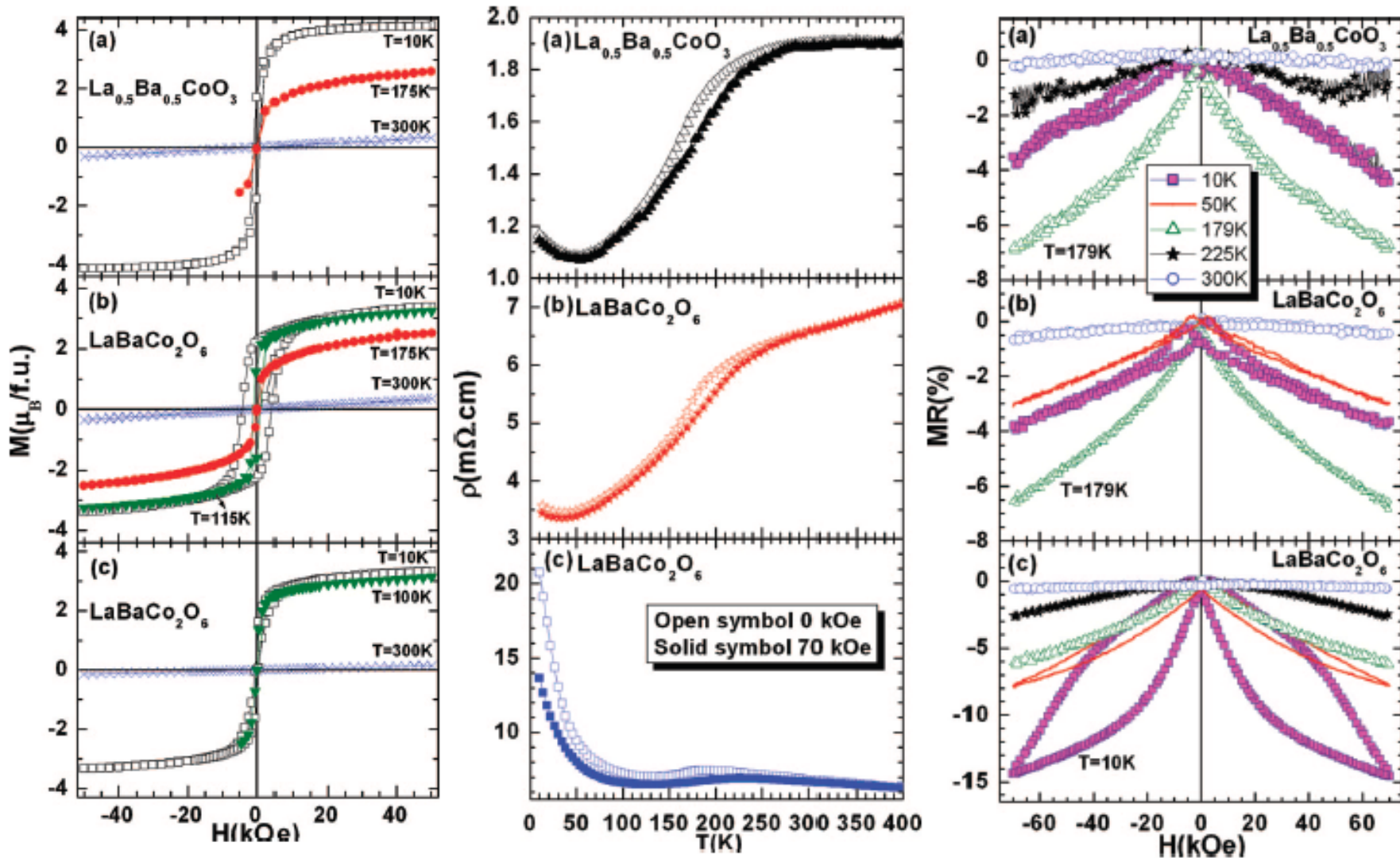



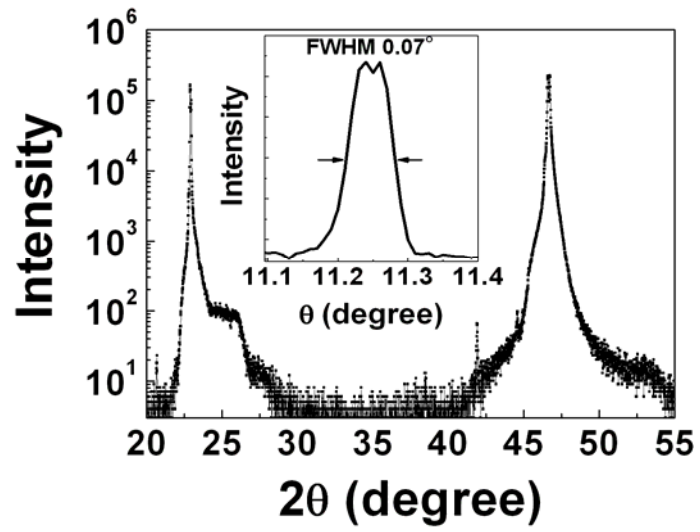
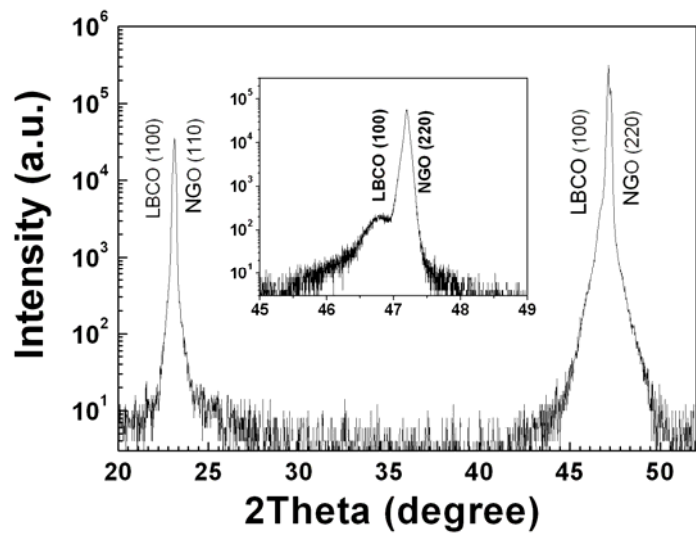
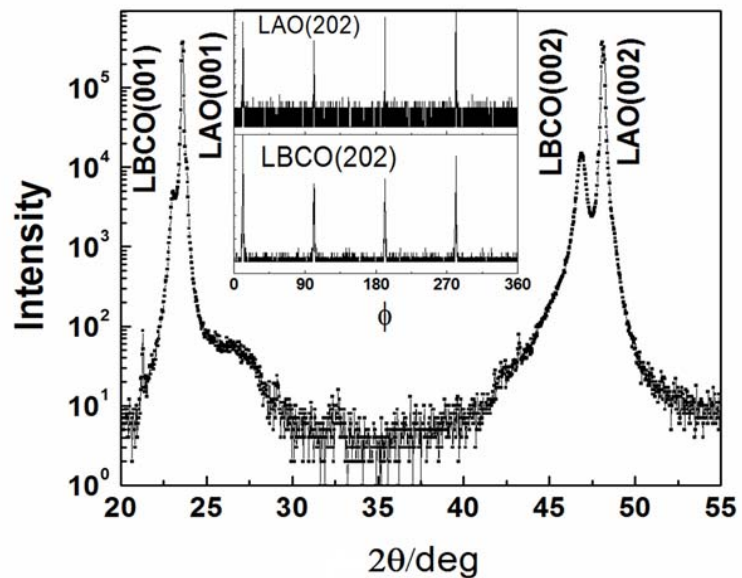
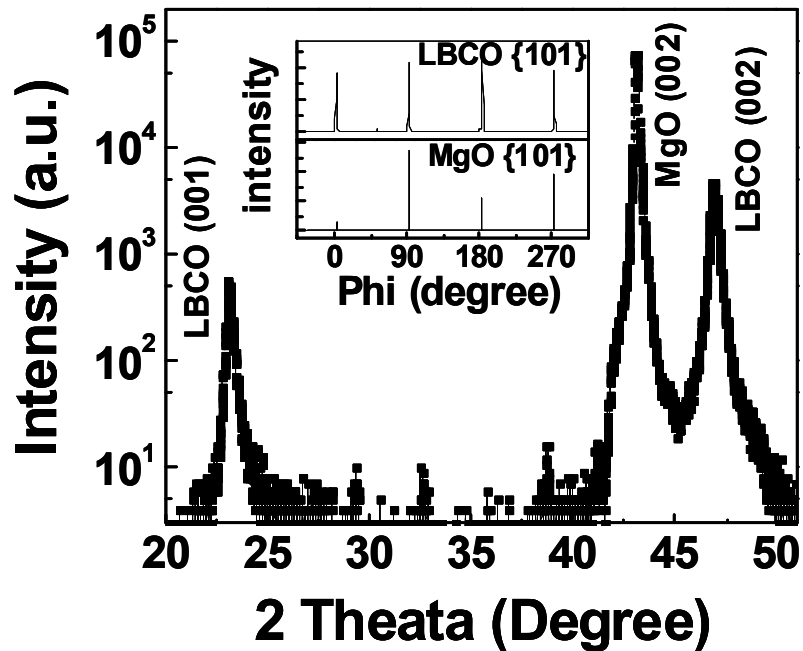

# Nanoscale ordered cobaltite $\text{LaBaCo}_2\text{O}_6$

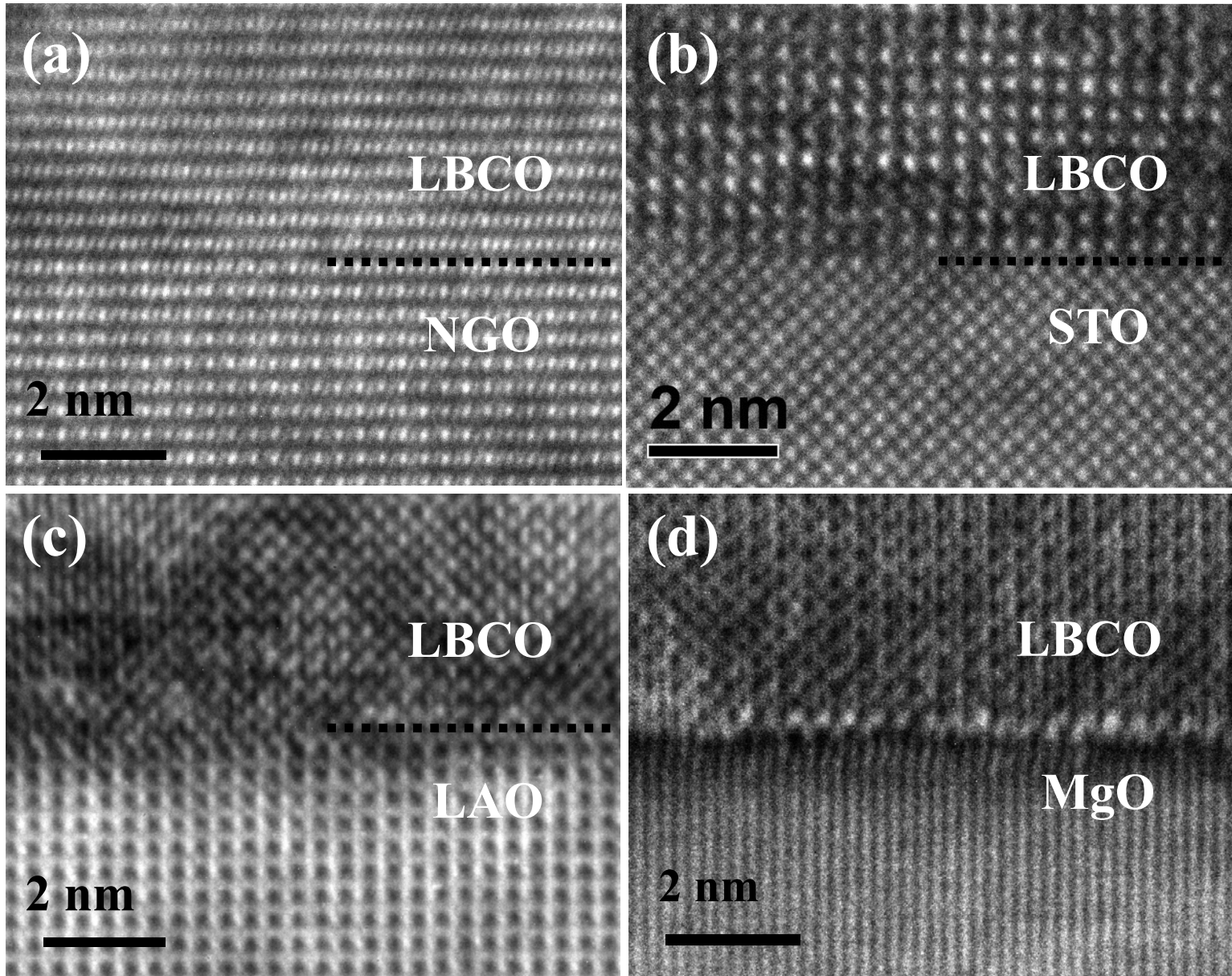

# Highly epitaxial nanoscale ordered cobaltite $\text{LaBaCo}_2\text{O}_6$ thin films

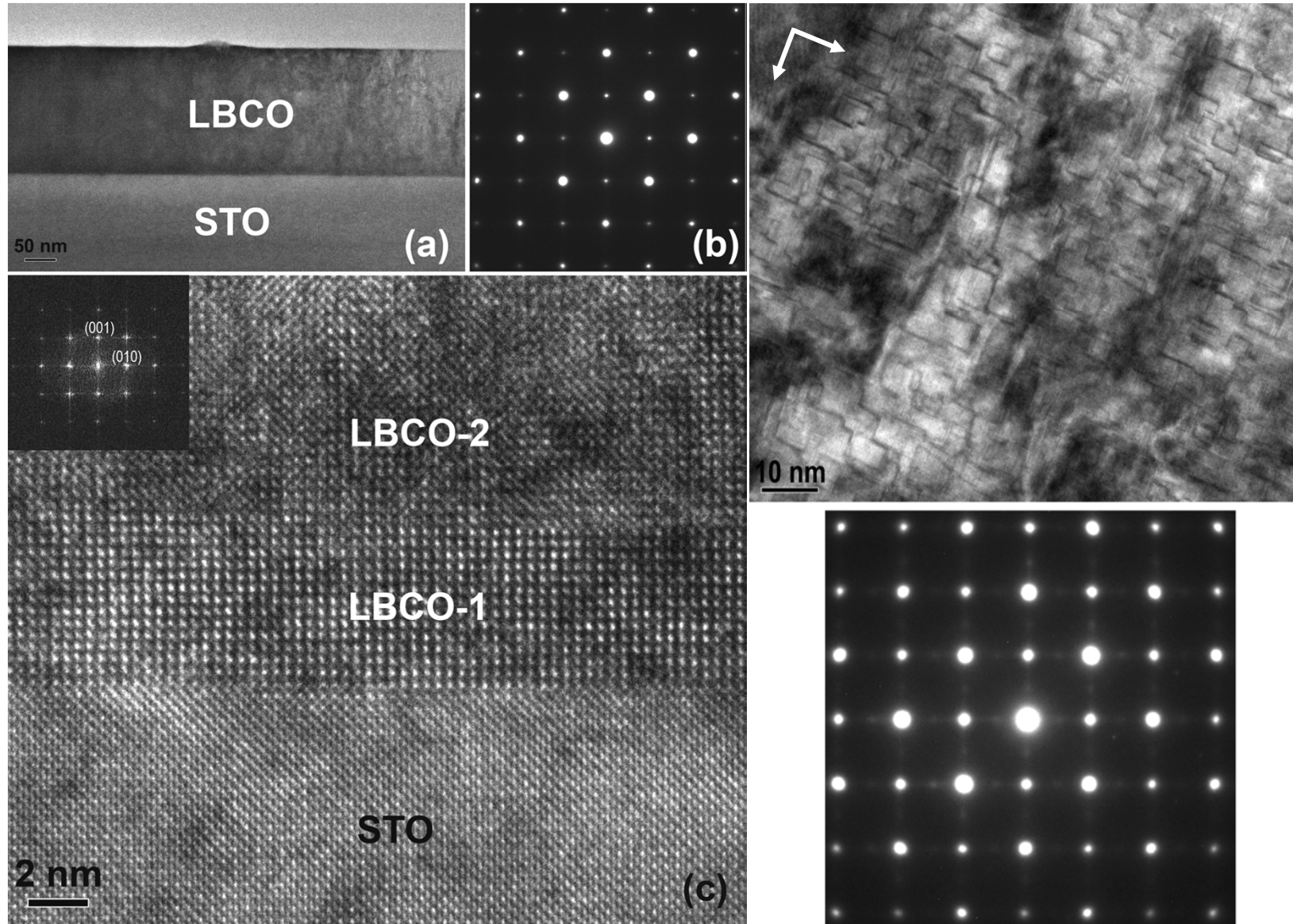

# Nanoscale ordered $\text{LaBaCo}_2\text{O}_6$ thin films

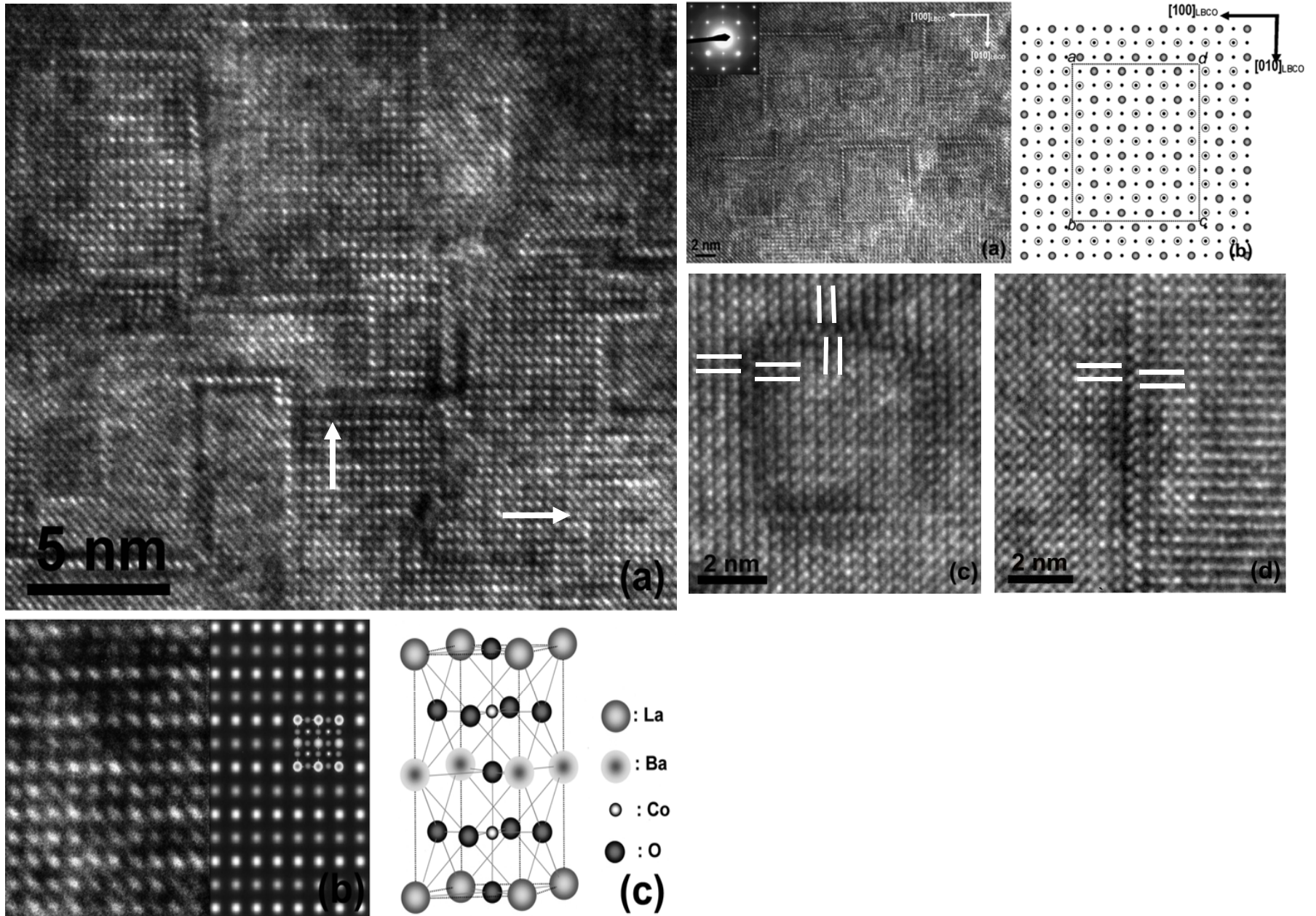

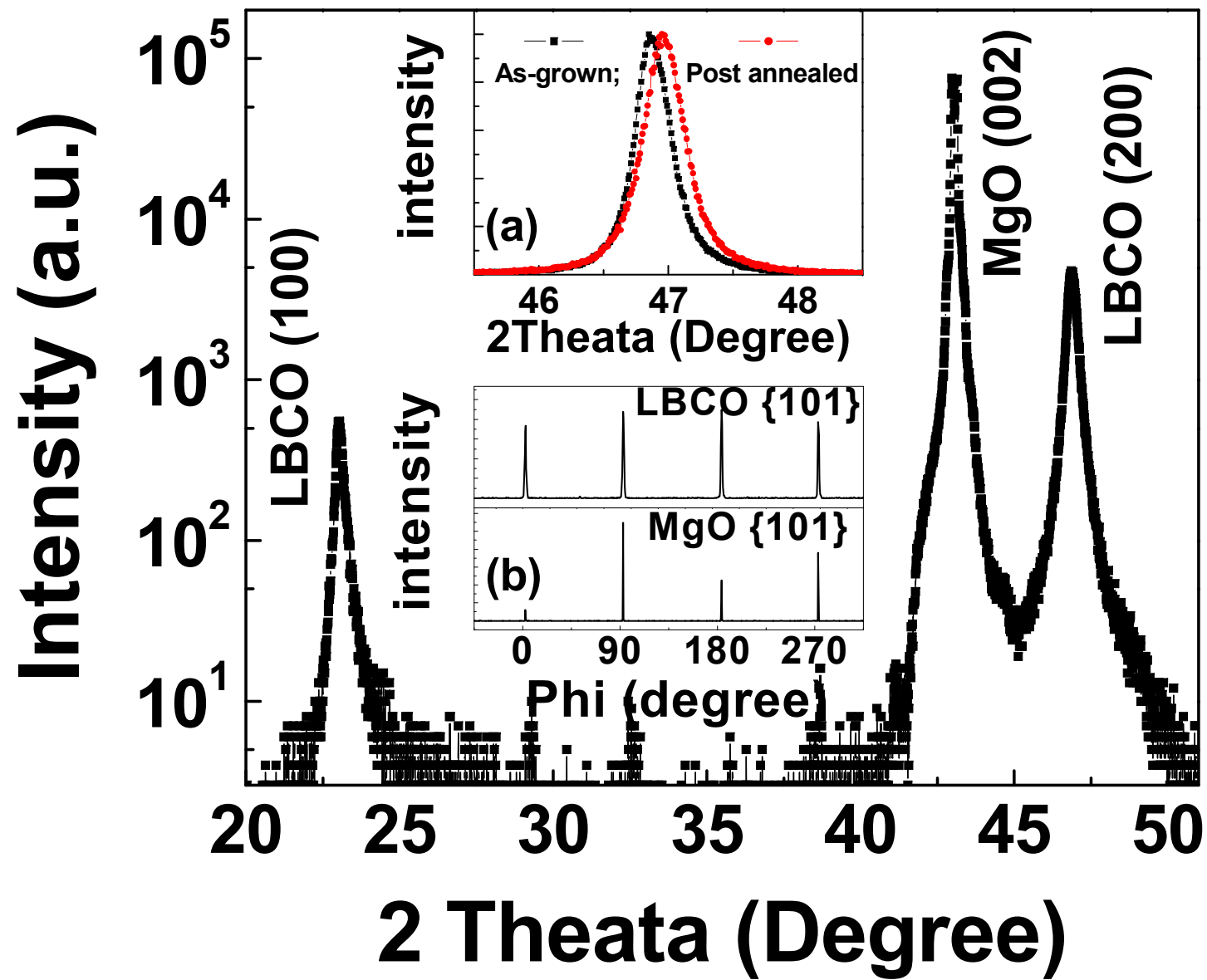

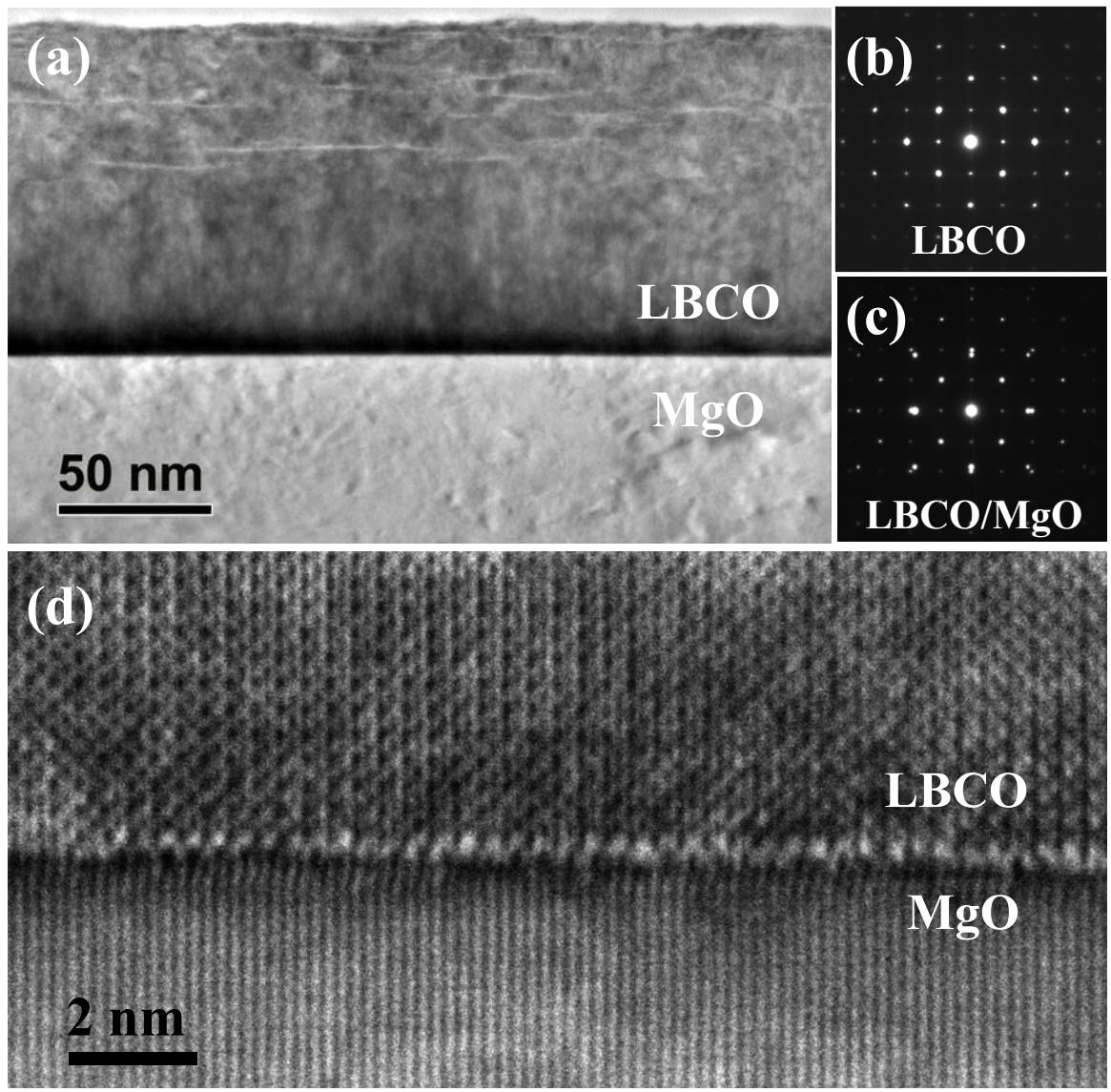

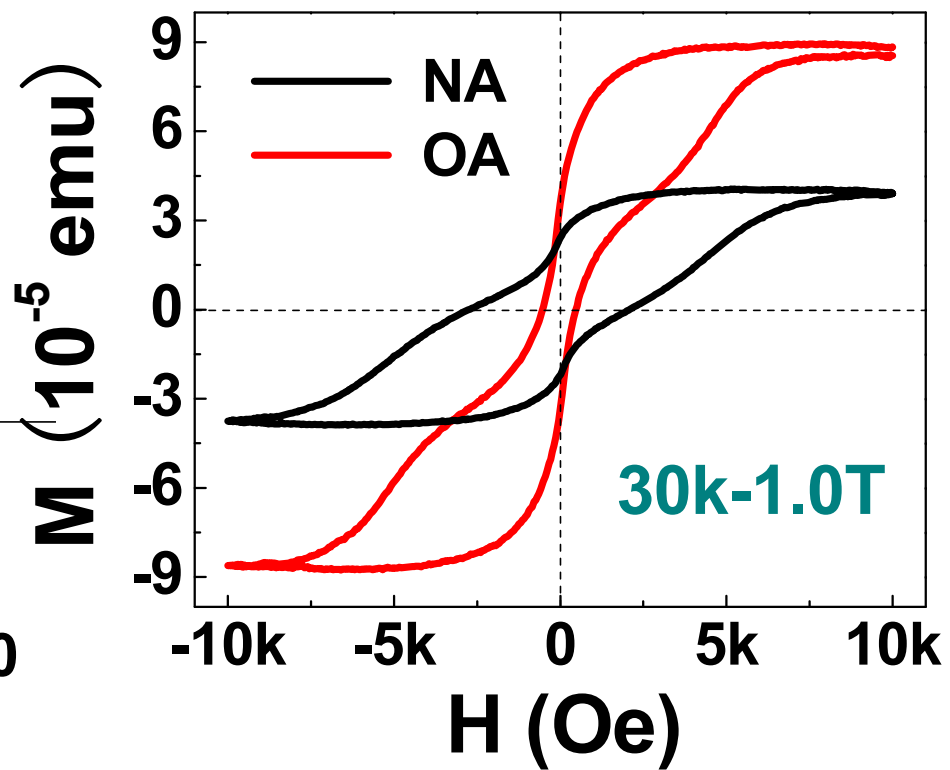
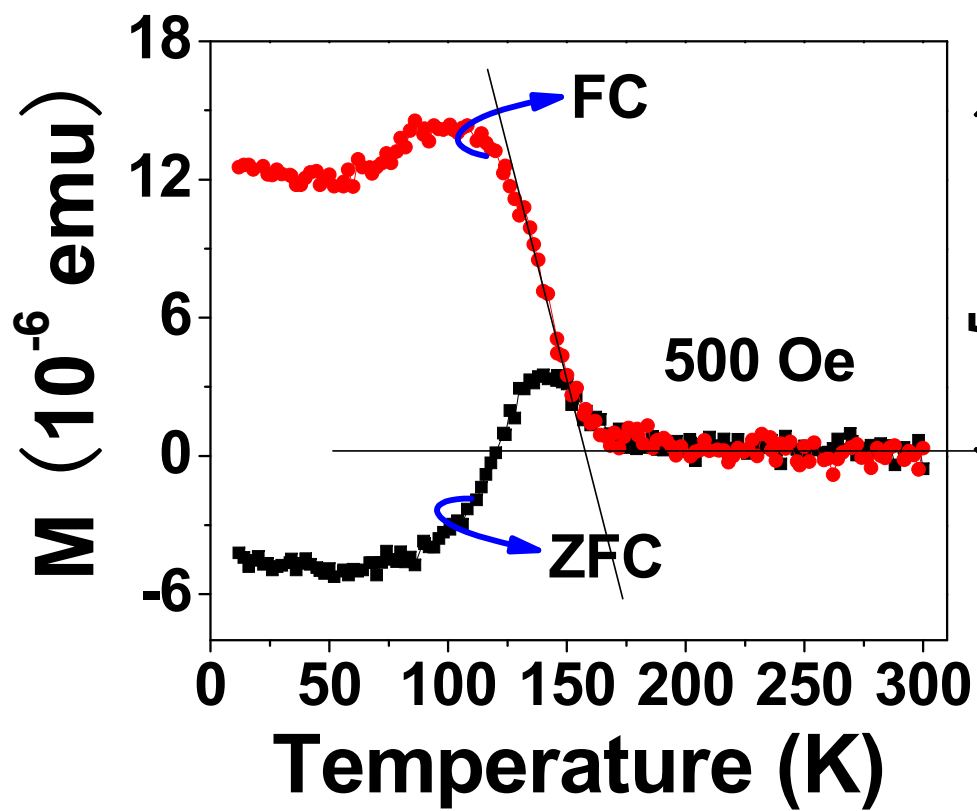

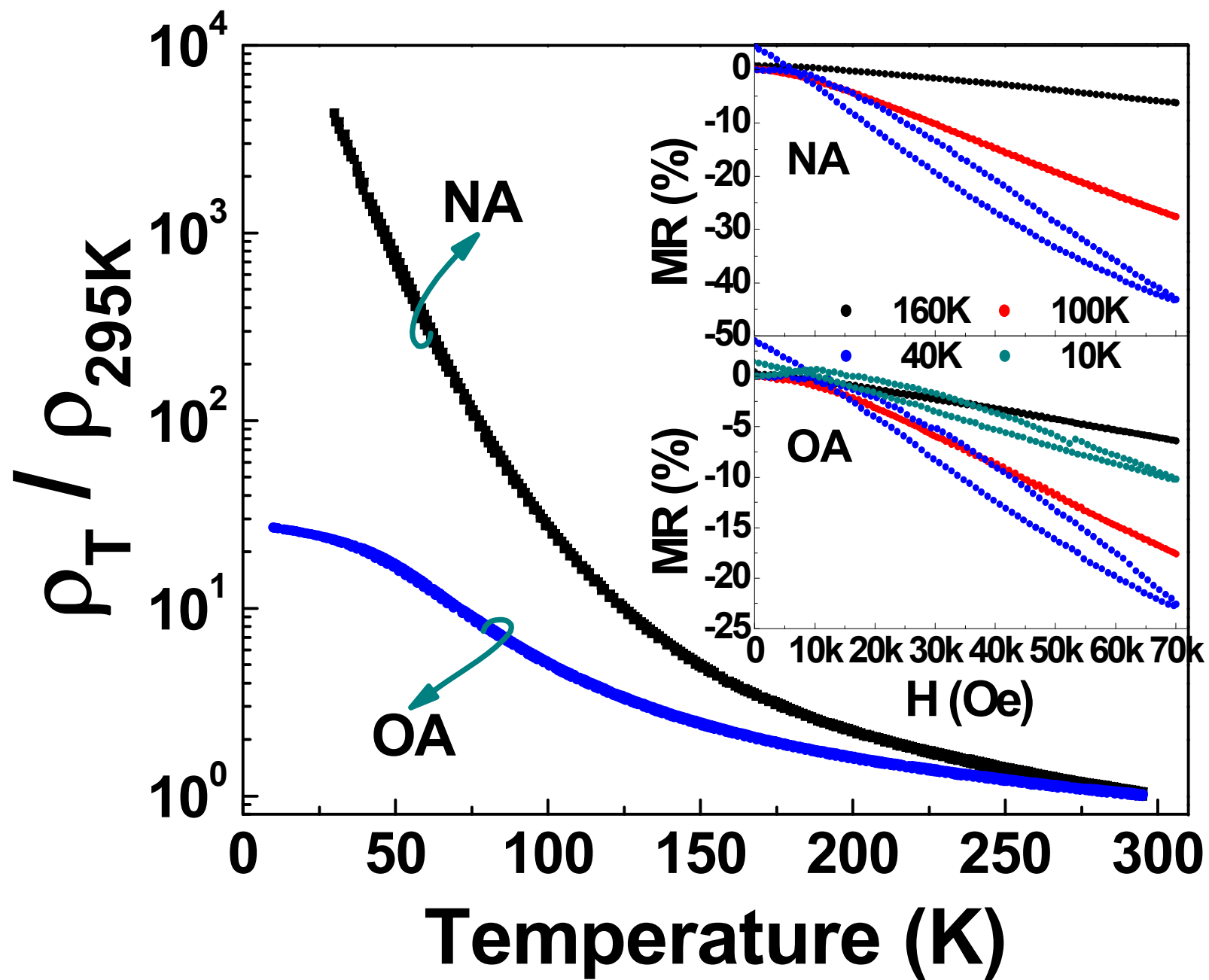



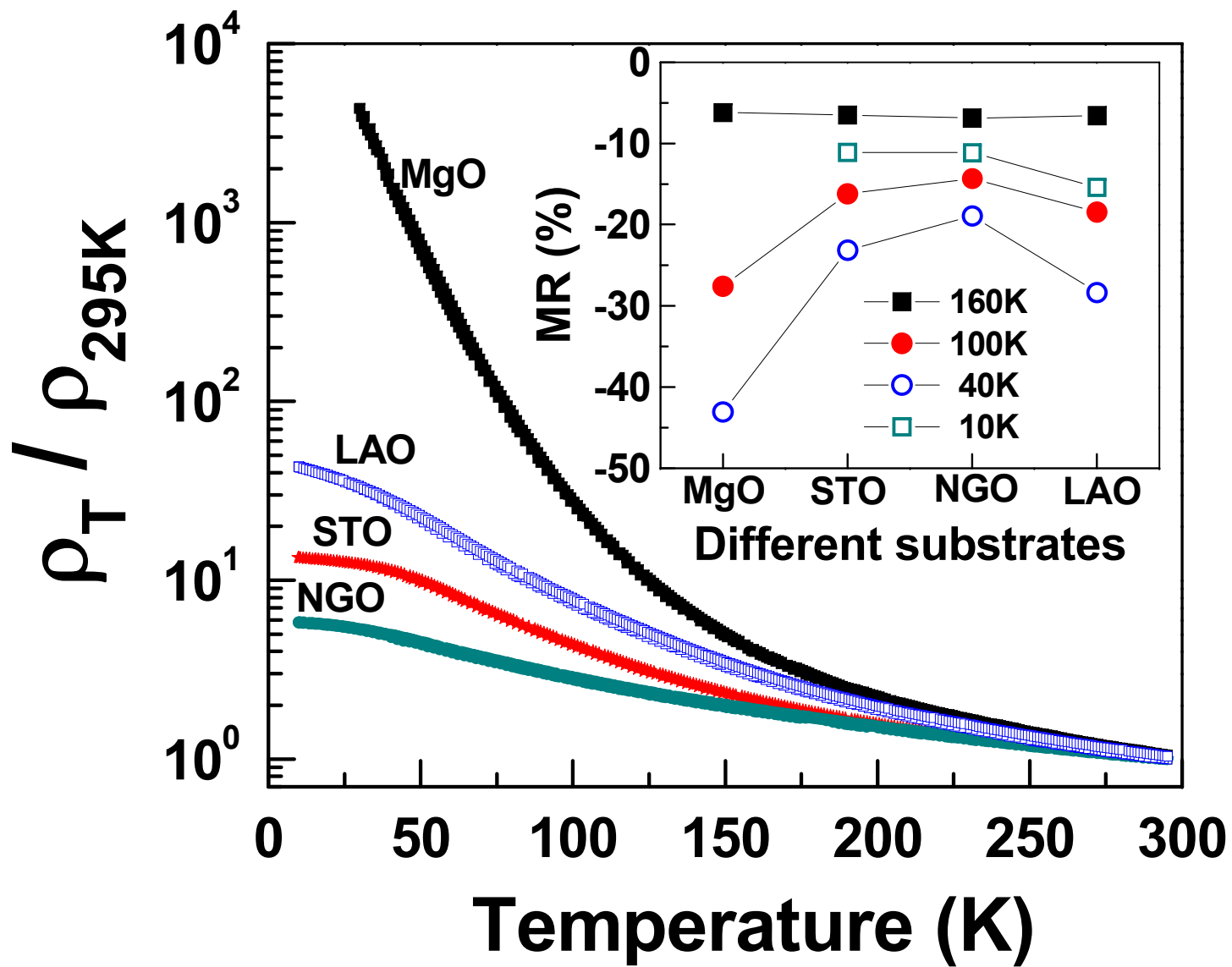

# Substrate-induced Strain on Transport Behavior and Magnetic Properties of Highly Epitaxial $(\text{LaBa})\text{Co}_2\text{O}_{5.5+\delta}$ Thin Films

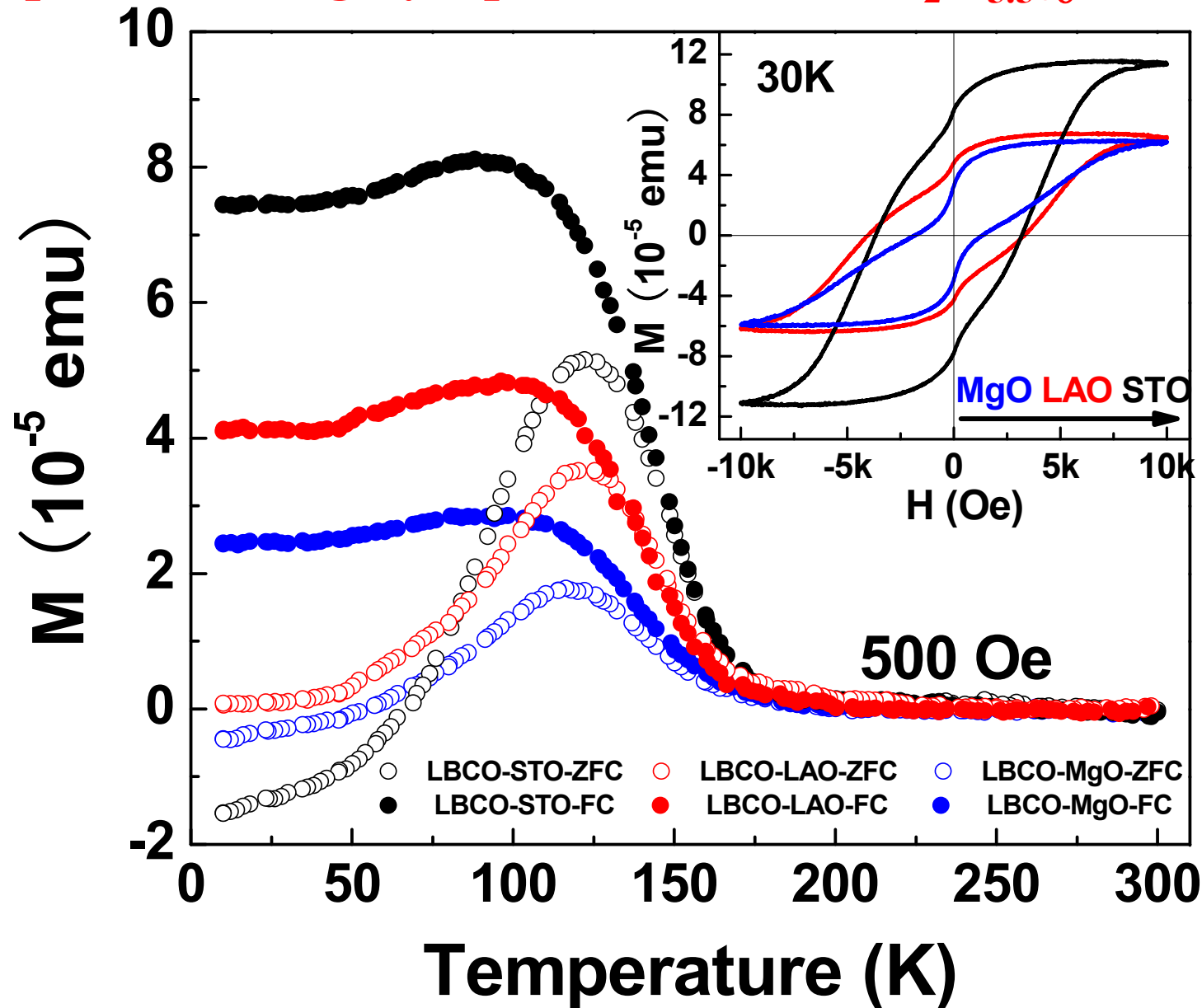

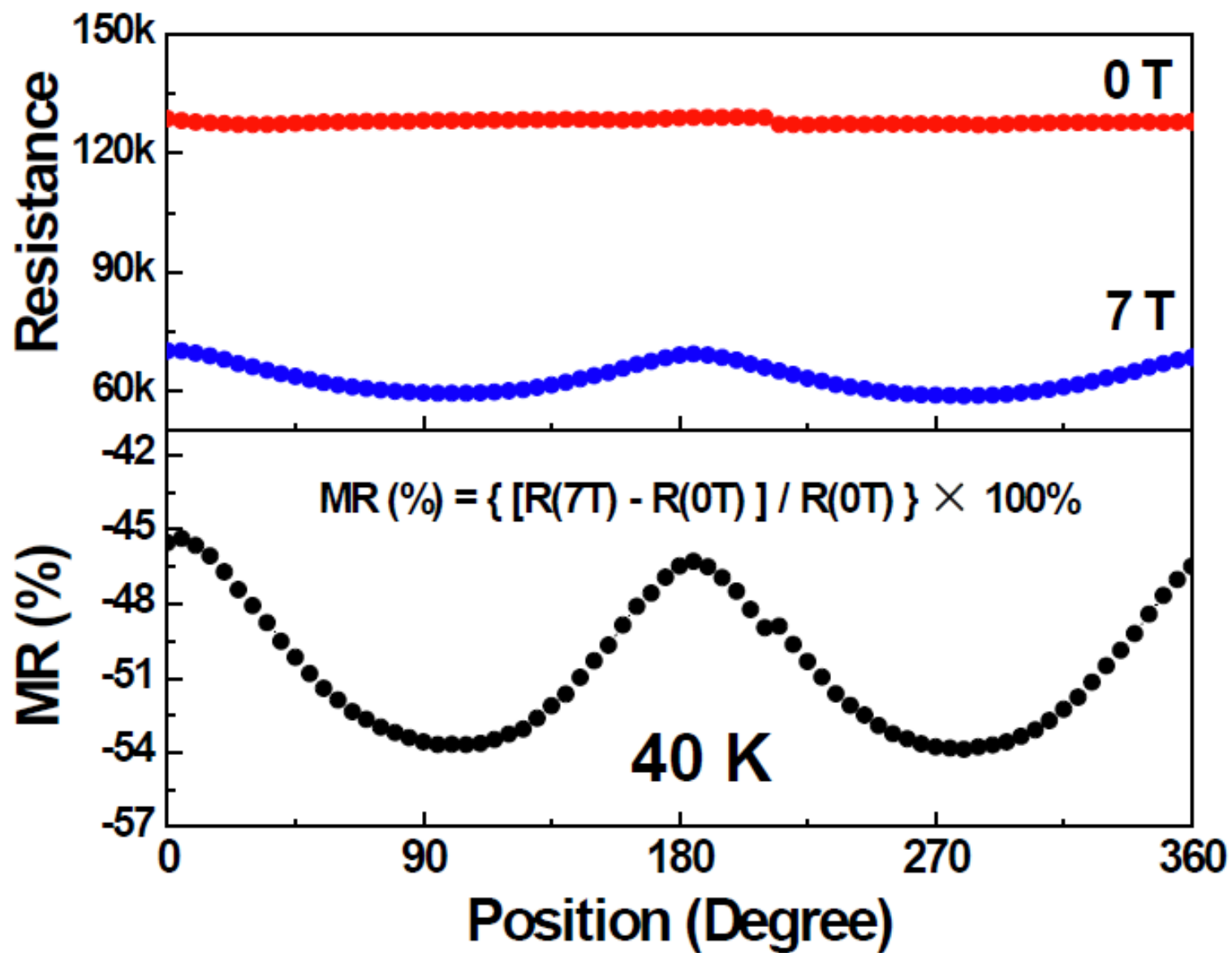

# Strain from Various Film Thickness

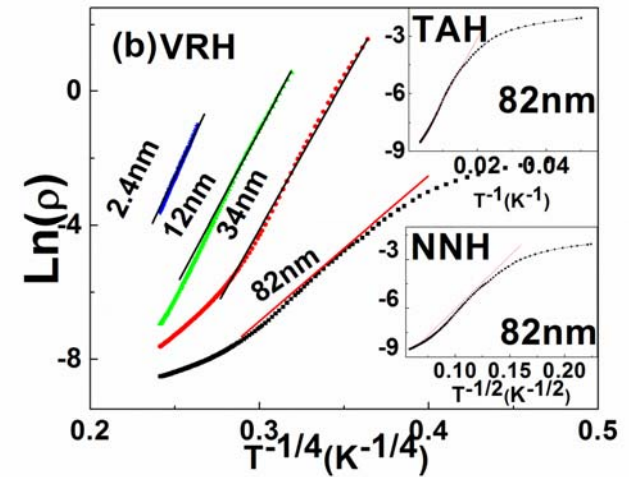
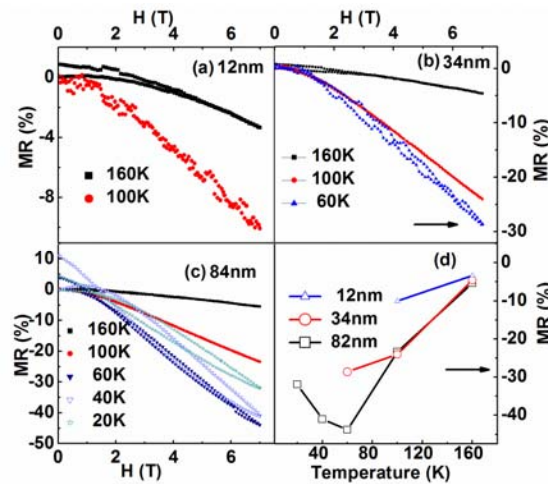
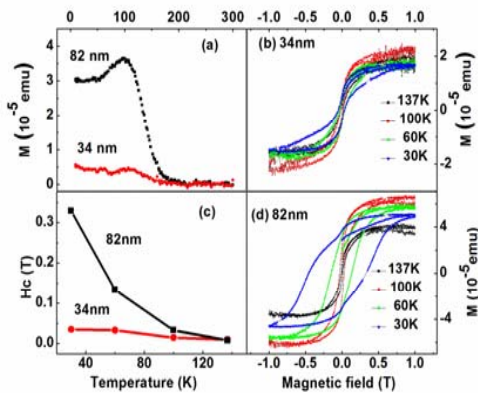
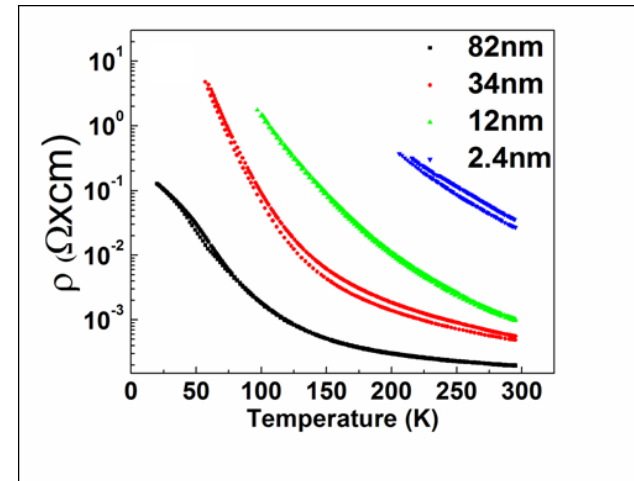
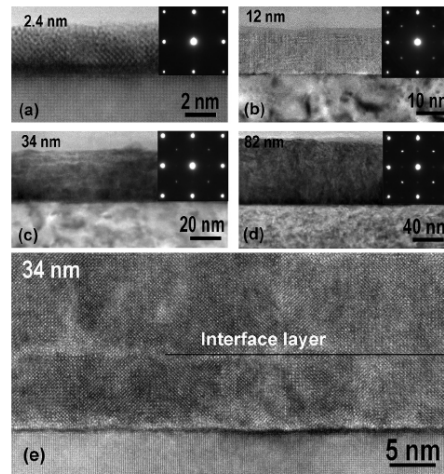
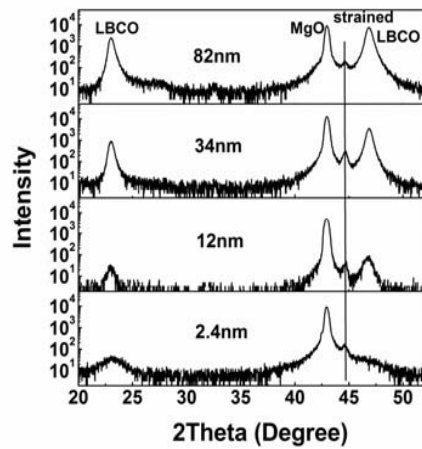

# Interface Strain From Vicinal substrate

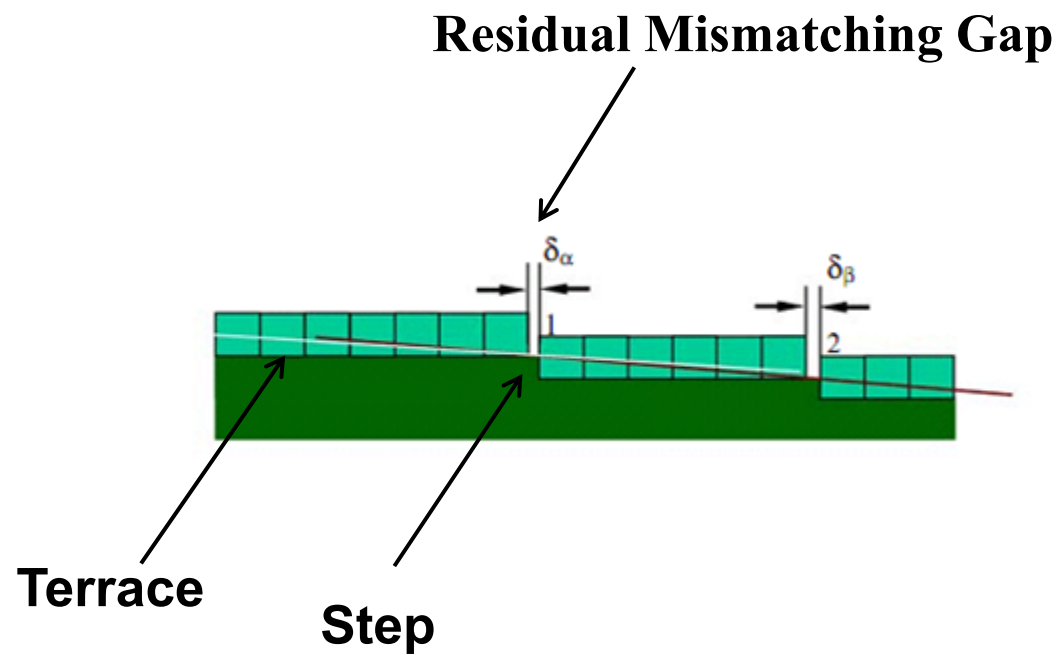

# X-ray Characterization of LBCO on Vicinal Substrate

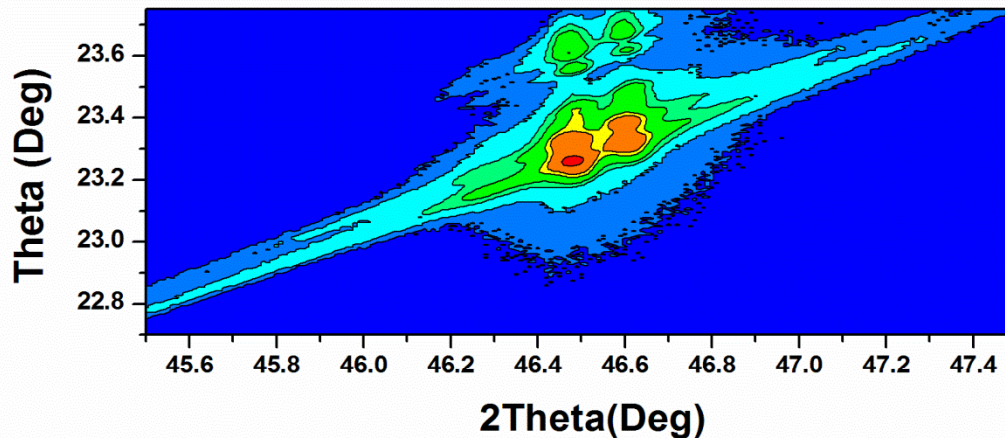

**Substrate FWHM:  $0.04^\circ$**

**Film FWHM:  $0.05^\circ$**

**Good Epitaxial Quality**

The average width of the substrate terrace in the epitaxial LBCO thin films grown on the vicinal (001) SrTiO<sub>3</sub>, and how many unit cells of the substrate SrTiO<sub>3</sub> and LaBCO ( $n_s$  and  $n_f$ , respectively) that the average terrace can accommodate

Specimen	Terrace width (nm)	$N_s$	$N_f$
0.5°	44.748	114.6	115.16 0.5 unit cell
3°	7.458	19.1	19.2 0.1 unit cell
5°	4.474	11.46	11.52 0.06 unit cell

# Transport Properties of LBCO Thin Film on Vicinal Substrate

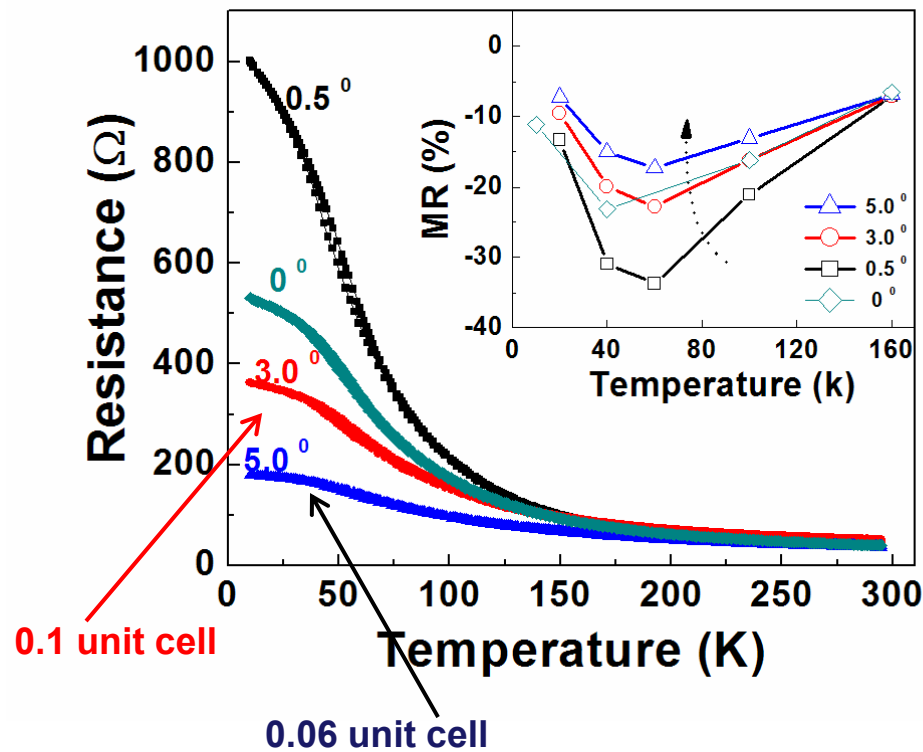

The terrace width is narrower and smaller than the mean surface atom diffusion length at the growth temperature. with increasing the miscut angle, the film growth will follow the step-flow mechanism resulting in the single domain formation. The single-domain growth and small lattice-misfit strain will reduce the scattering rate of the carriers with strain lattice and domain boundaries.

Step-flow



Local strain from terrace is very small



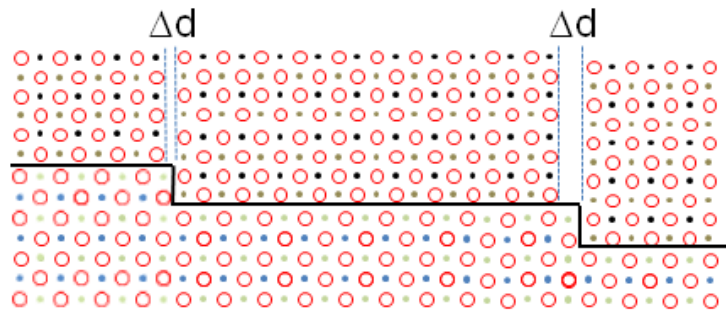

**Add an atomic plane**  
NC-APB



Locally Strained Domain

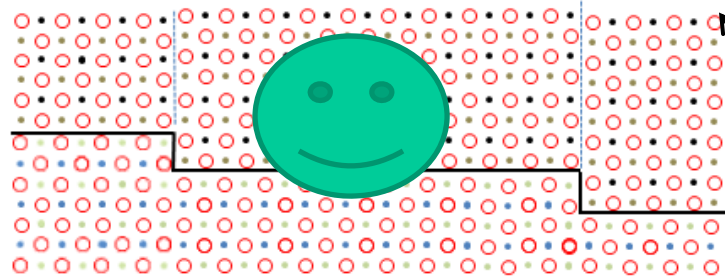

○ O    · Sr    · Ti    · Co    · La or Ba

## ~~Residual Mismatching Gap~~

The last atomic plane of the film will always occupy the terrace end by rearranging the local atomic structure

a huge amount of interface strain energy will be generated due to the same charge repulsion at the domain boundary and interface

Tensile strain in plane, compressive strain out of plane

locally-strained domain will enhance strong transport electron scattering behavior, inducing the higher resistance

# Interface Strain from Different Direction of the Same Substrate

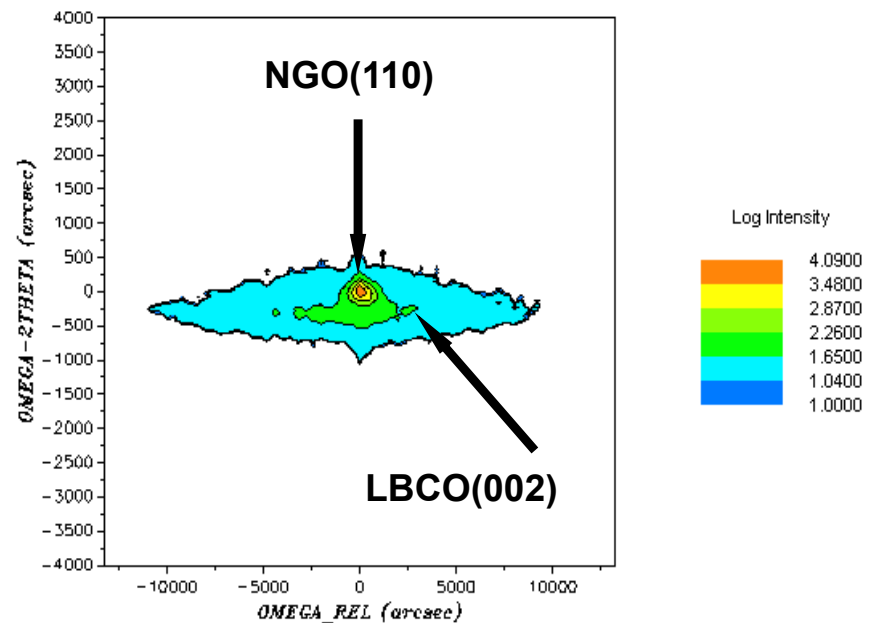
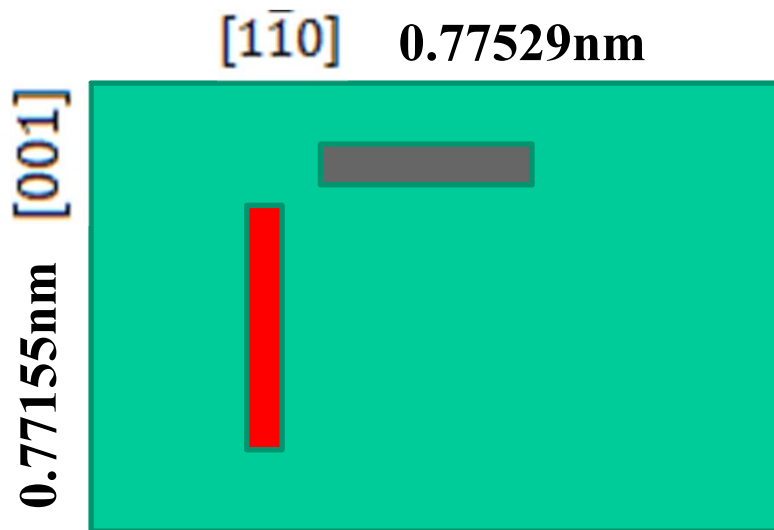

$[001]$  1.09% “1”

$[1\bar{1}0]$  0.6% “2”

**Compressive Strain**

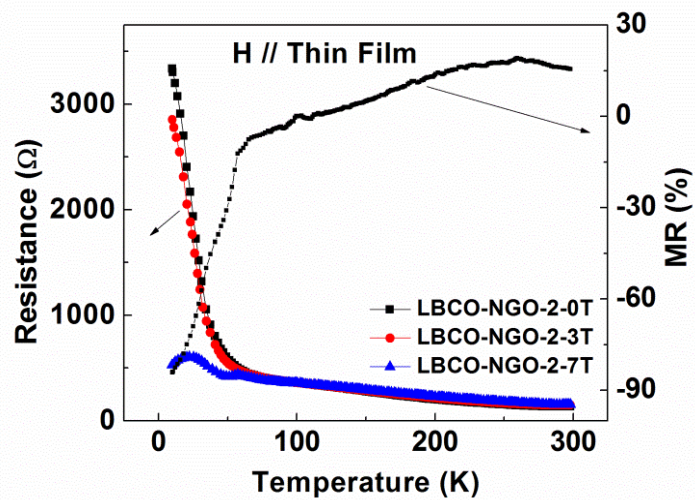
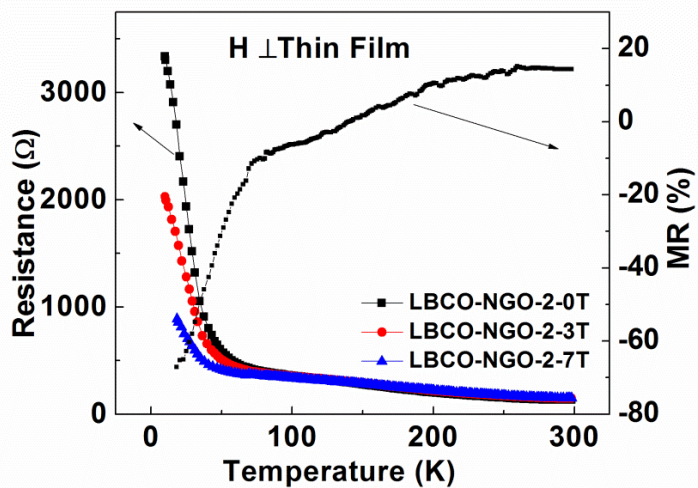
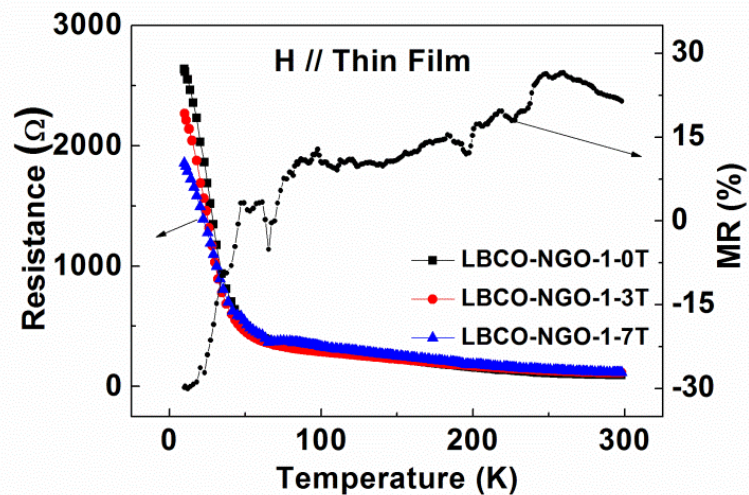
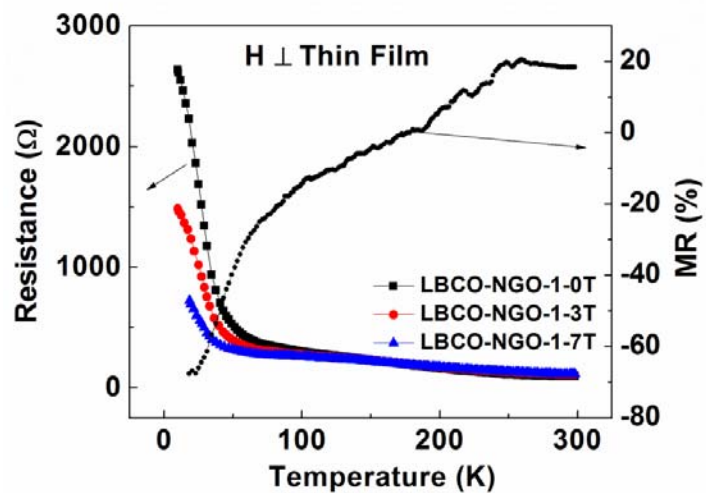
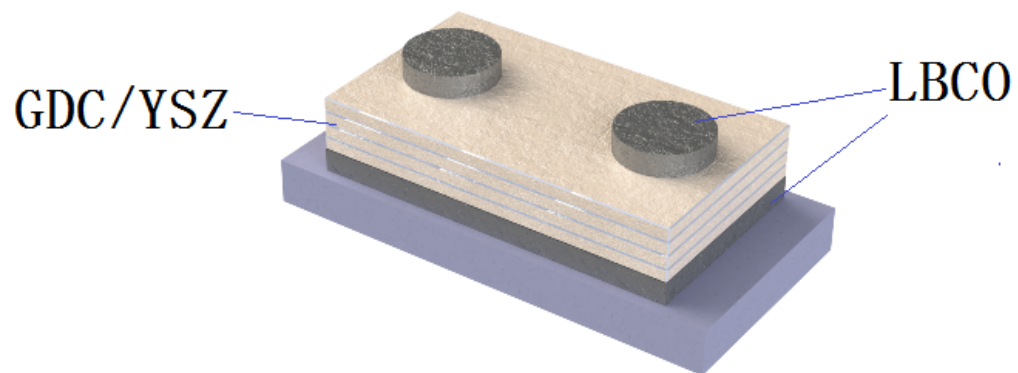
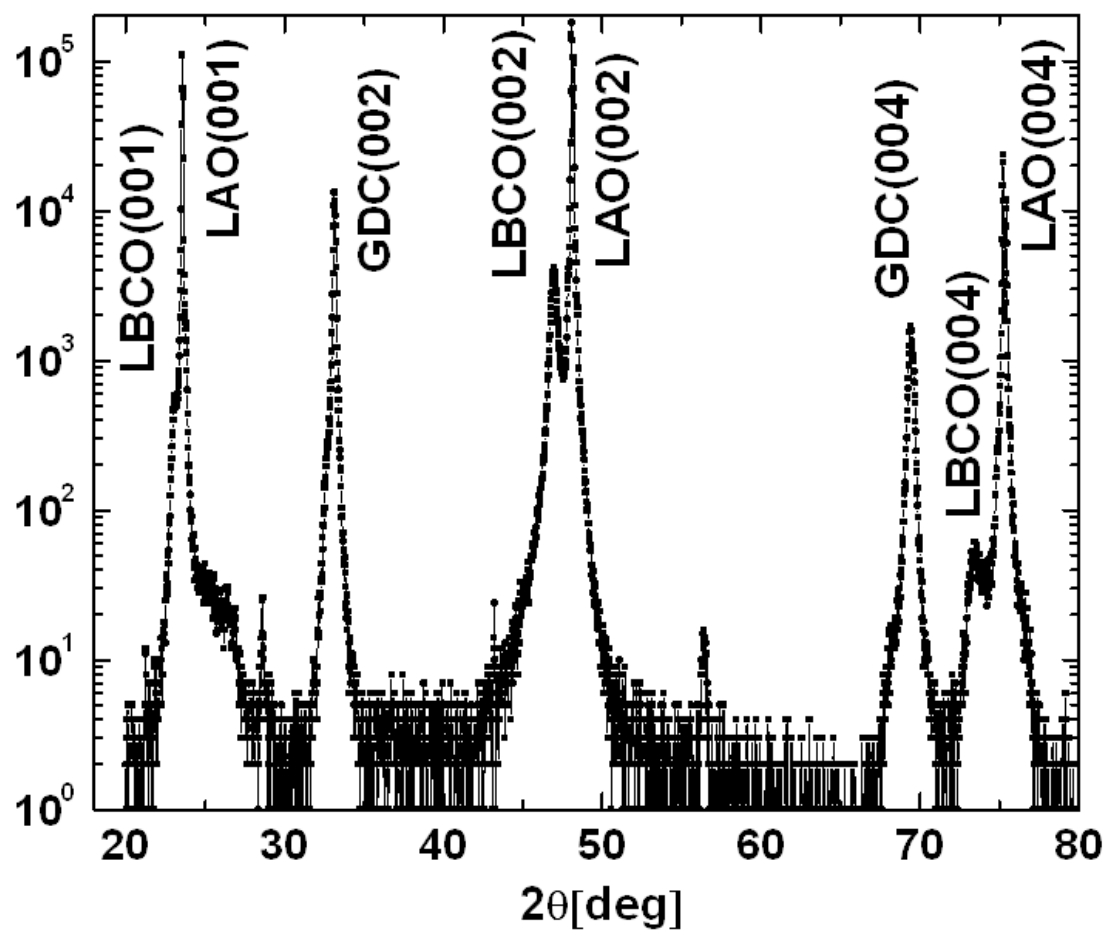

fig 1



*a*



*b*

fig 2 a

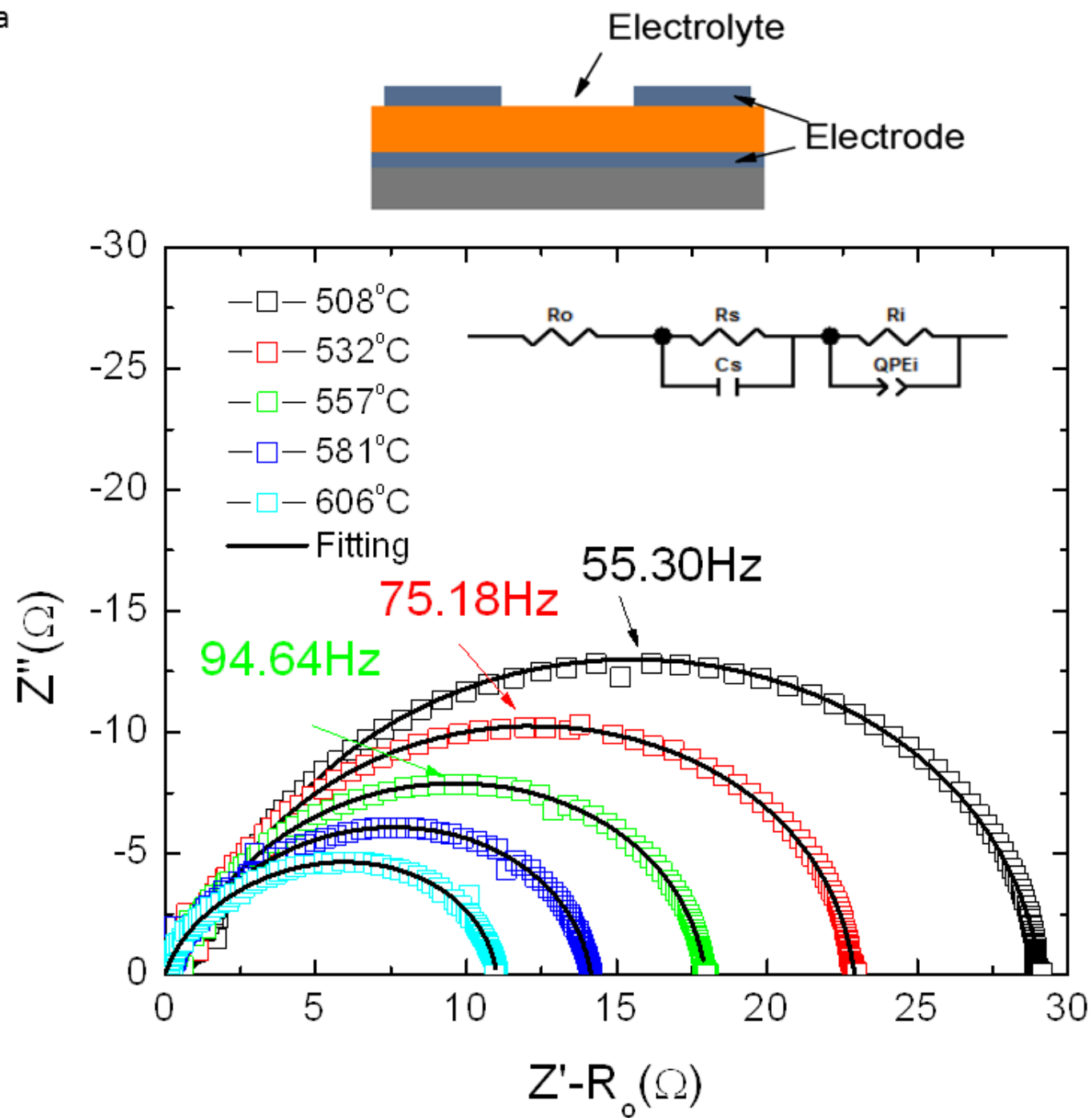

Figur2 b

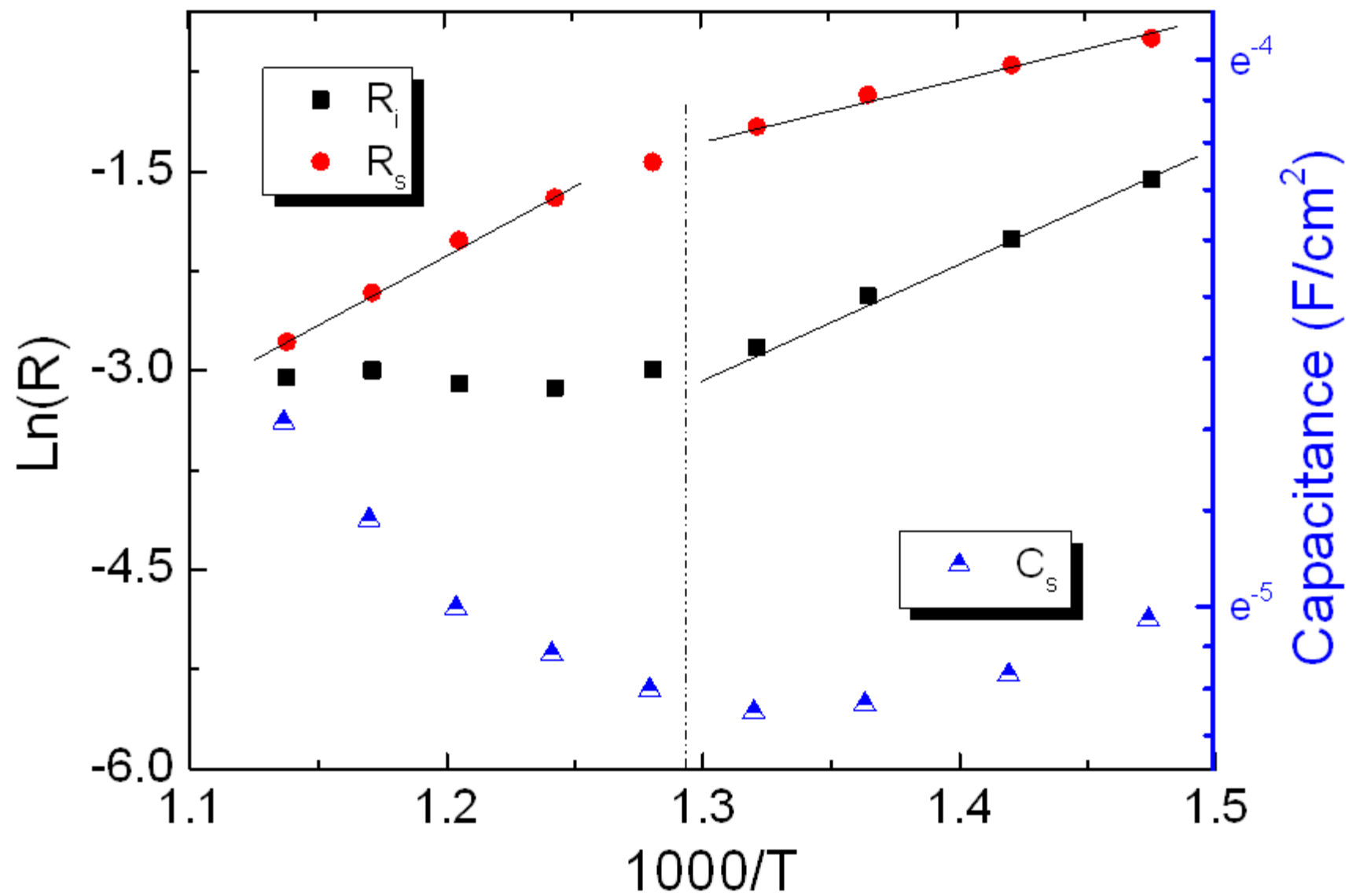
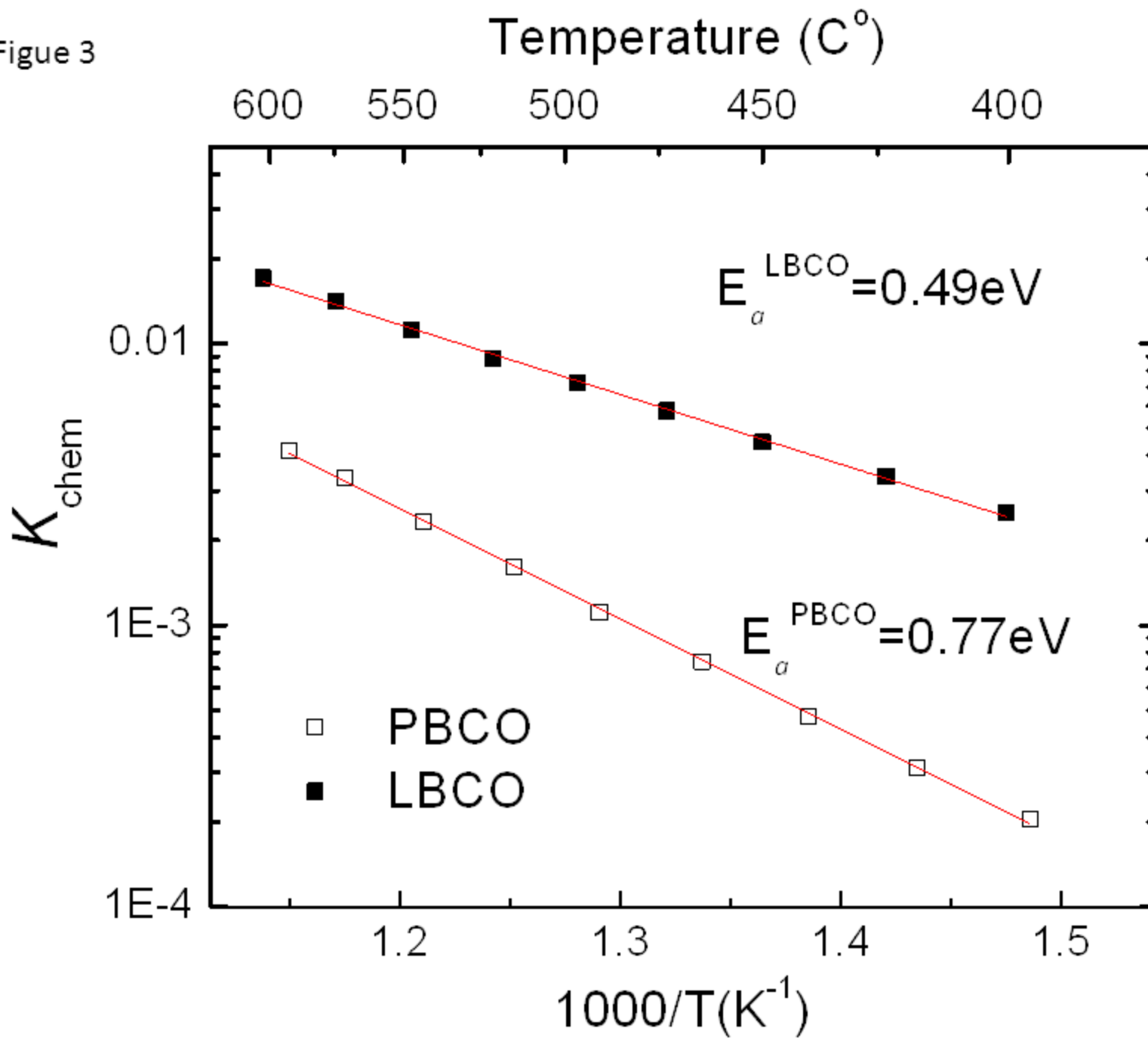
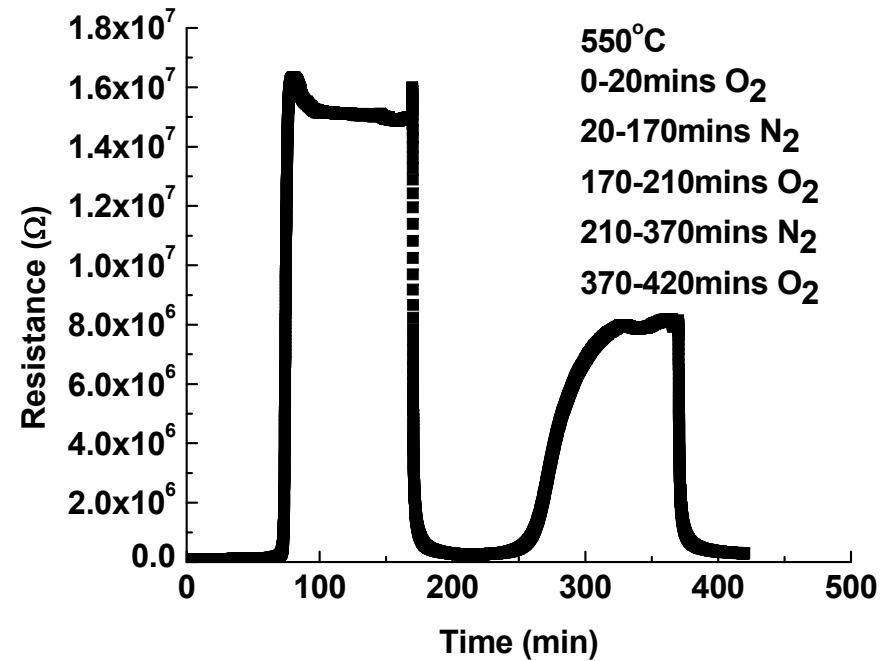
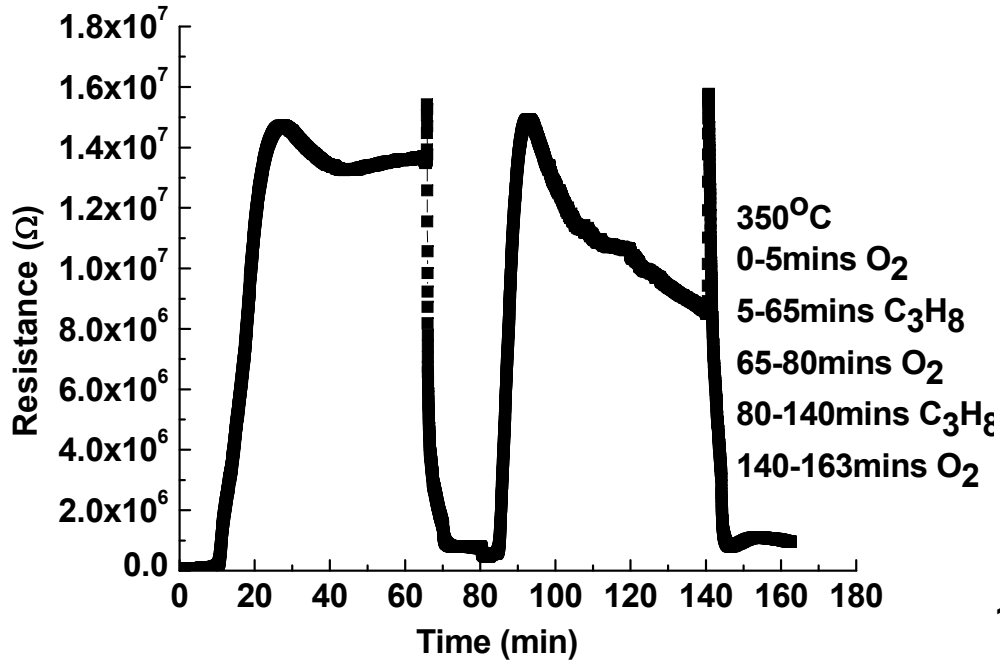

Figure 3



# LBCO Films in Other O<sub>2</sub>/Fuel Systems





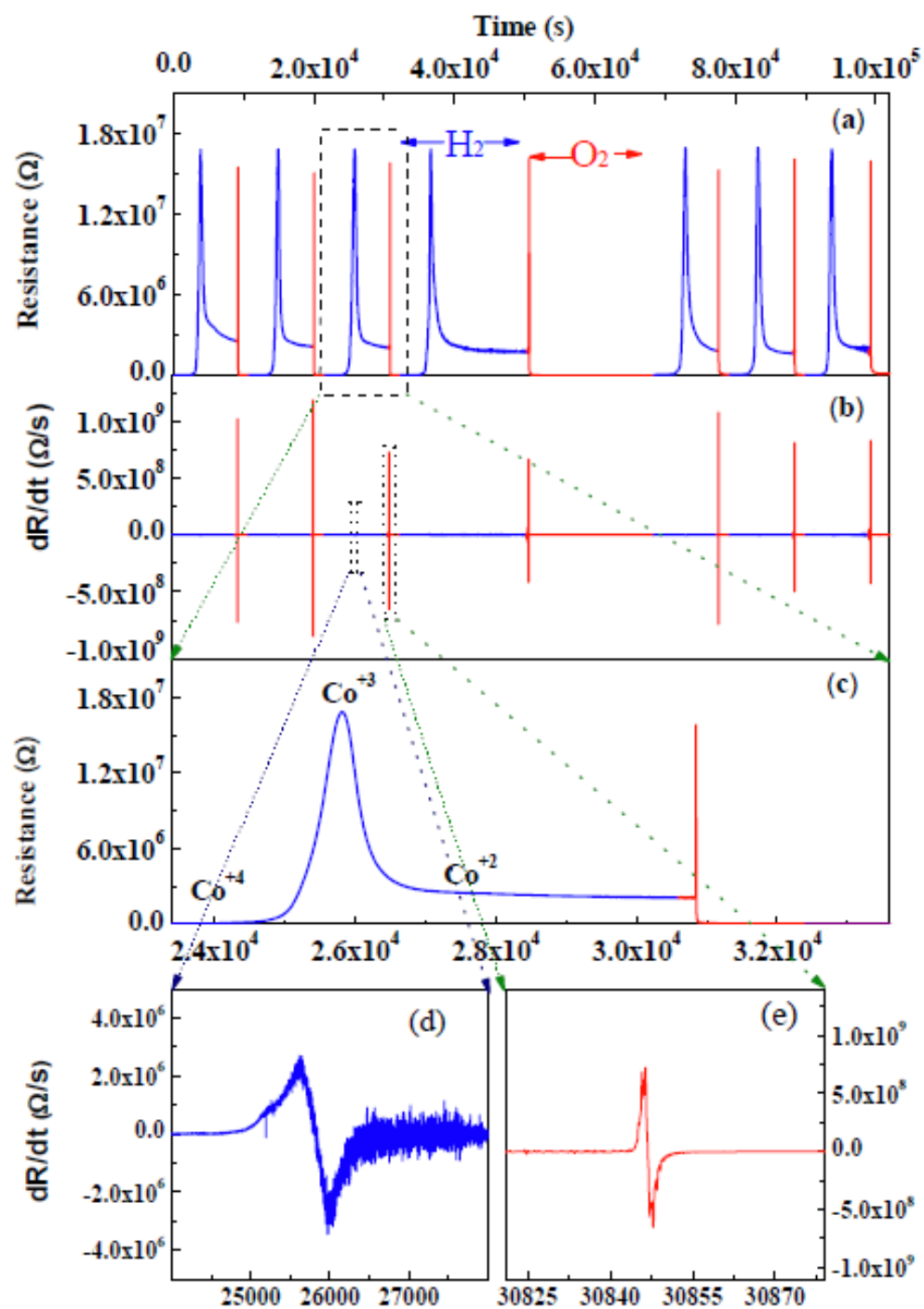

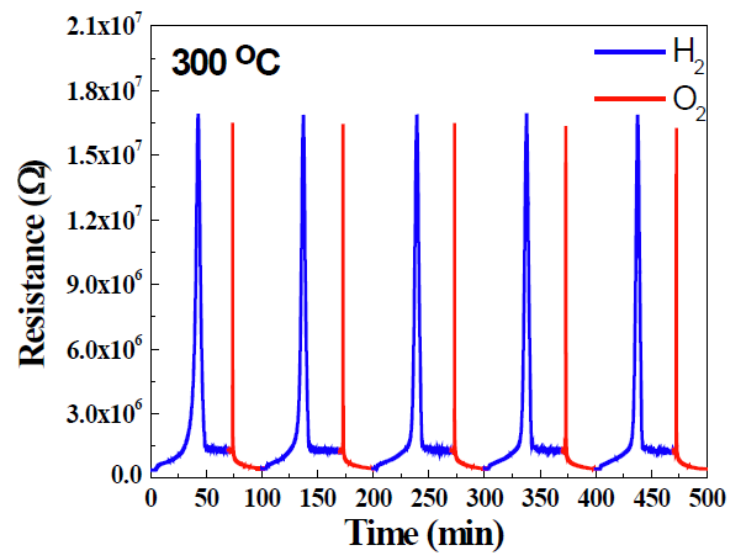
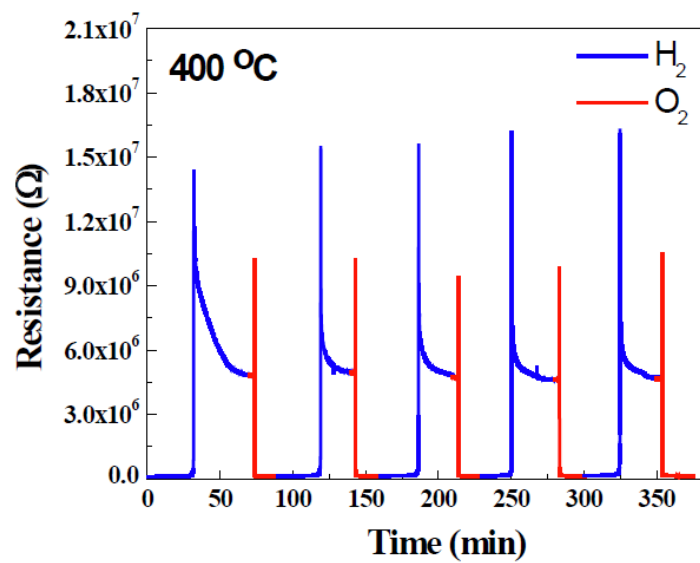
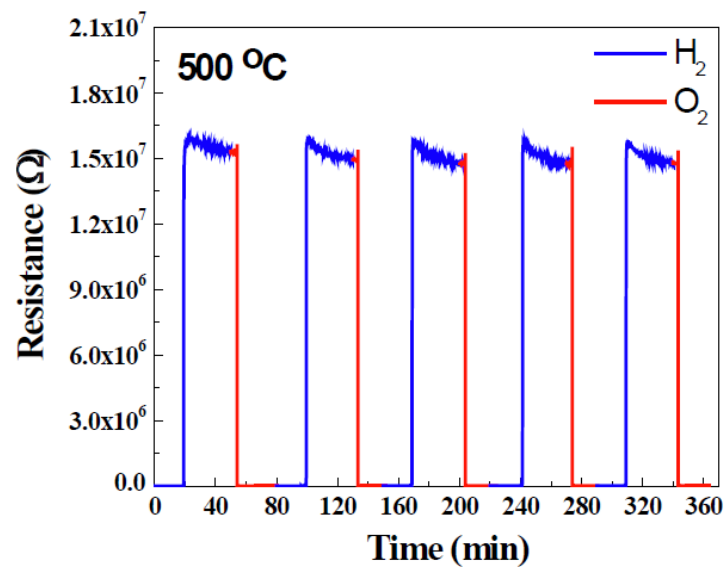
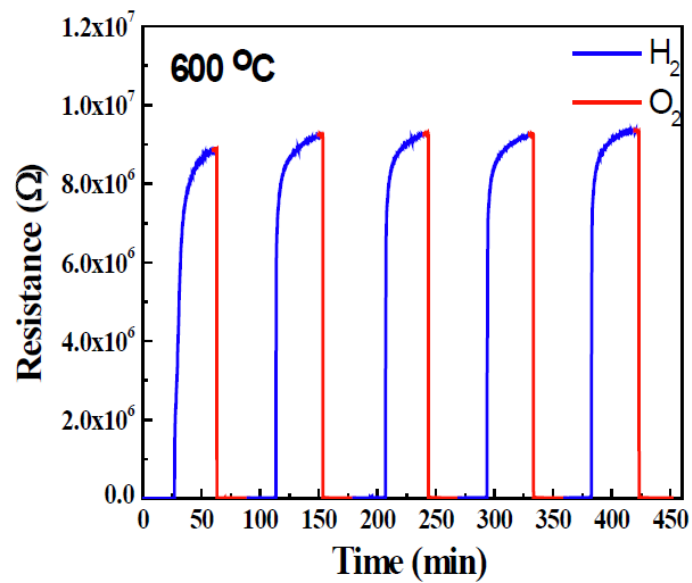

# LBCO Film Reduction Property :

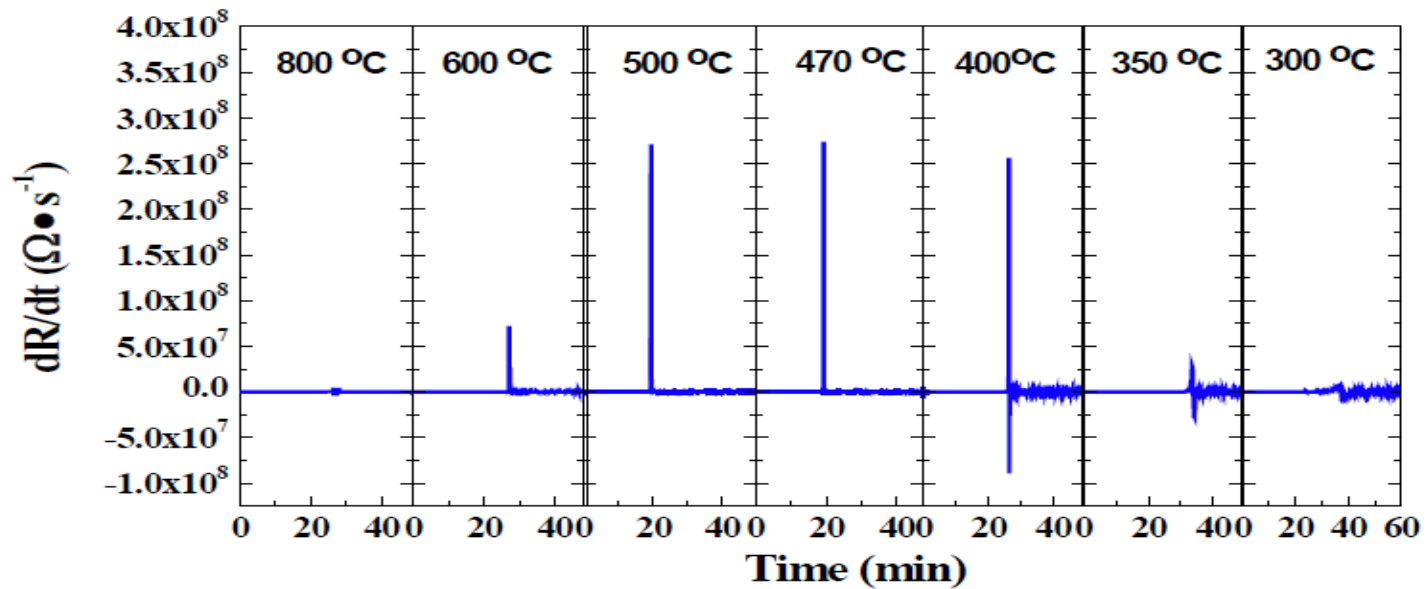
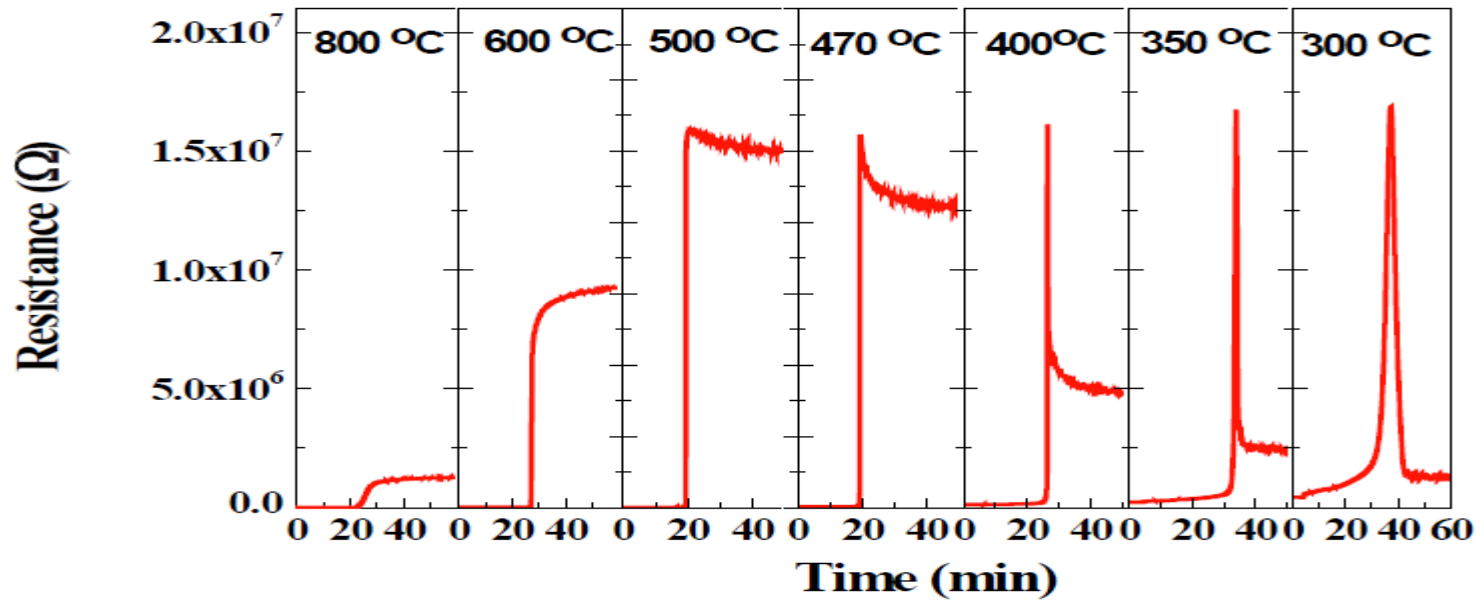

# EBCO Film Reduction Property :

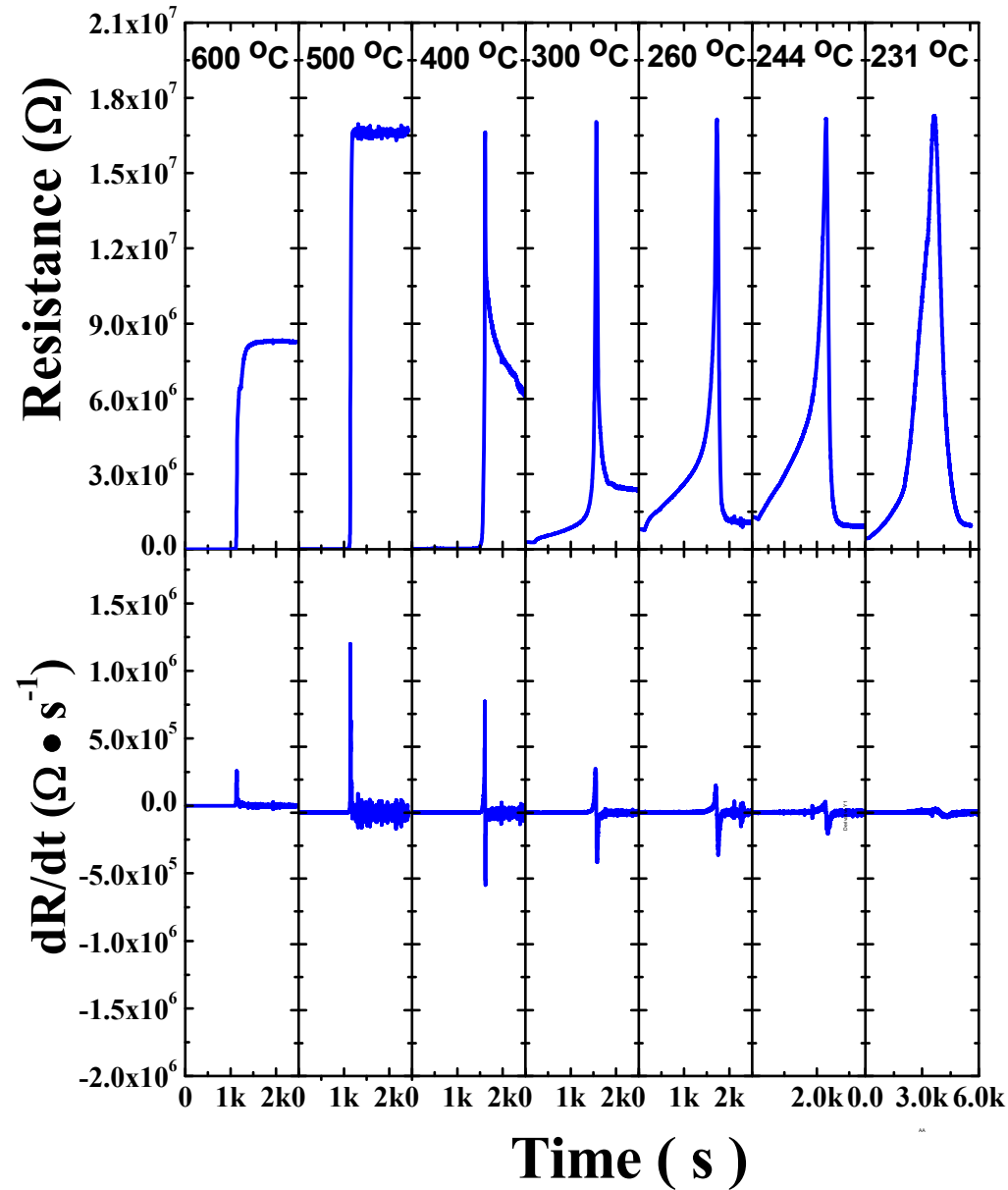

# EBCO Film Oxidation Property :

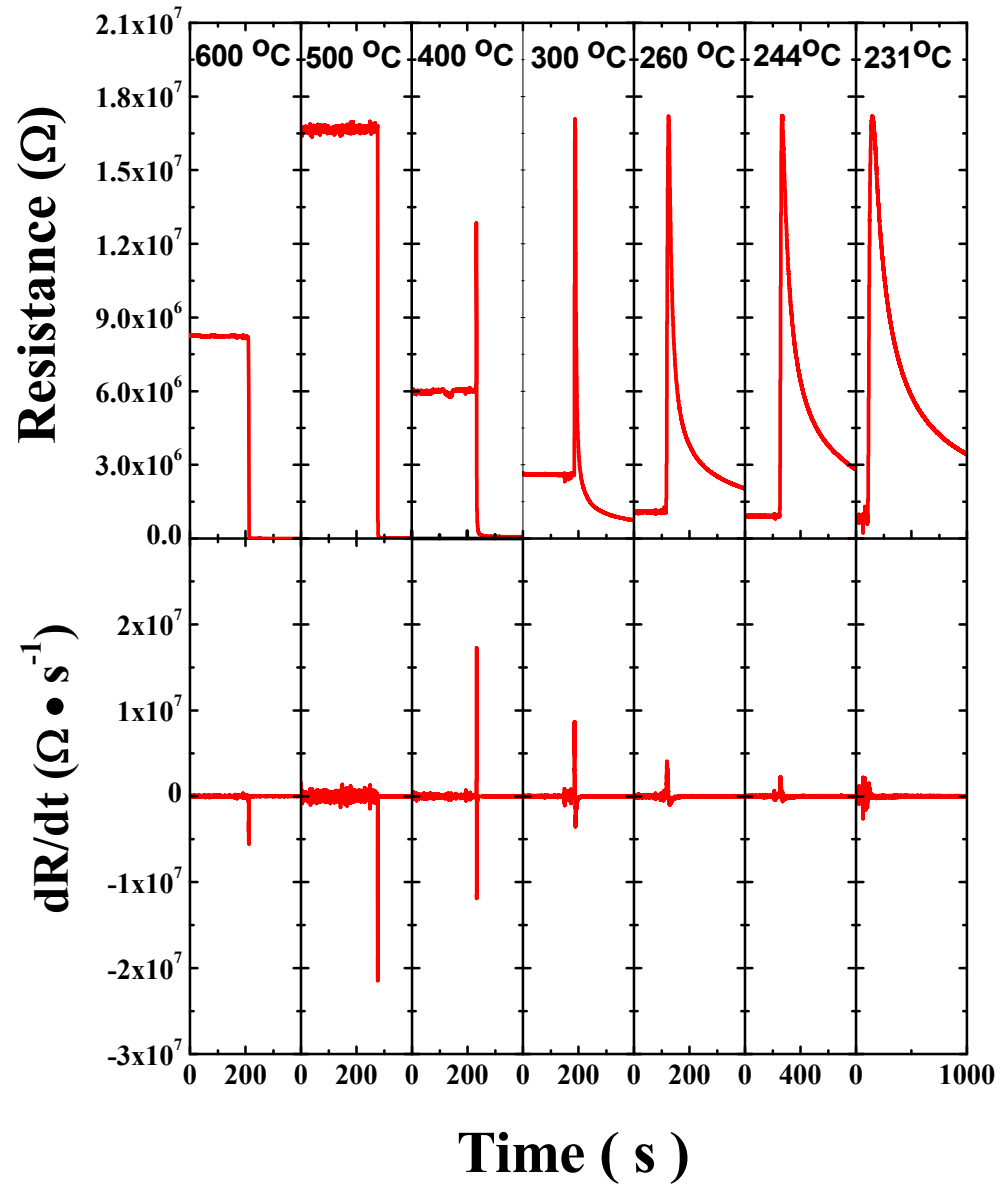

# EBCO Film Oxidation Property :

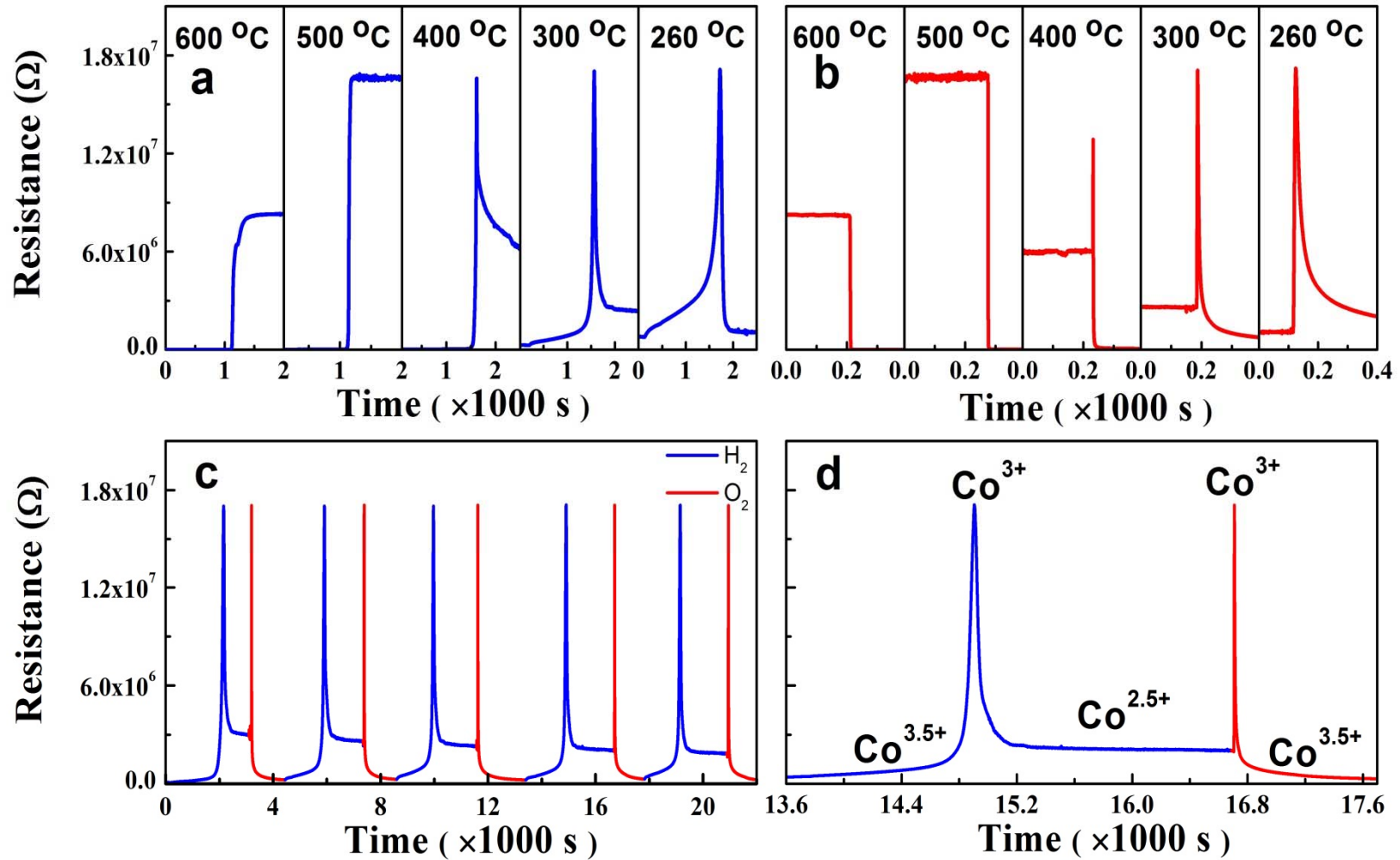

# PBCO Film Reduction Property :

---

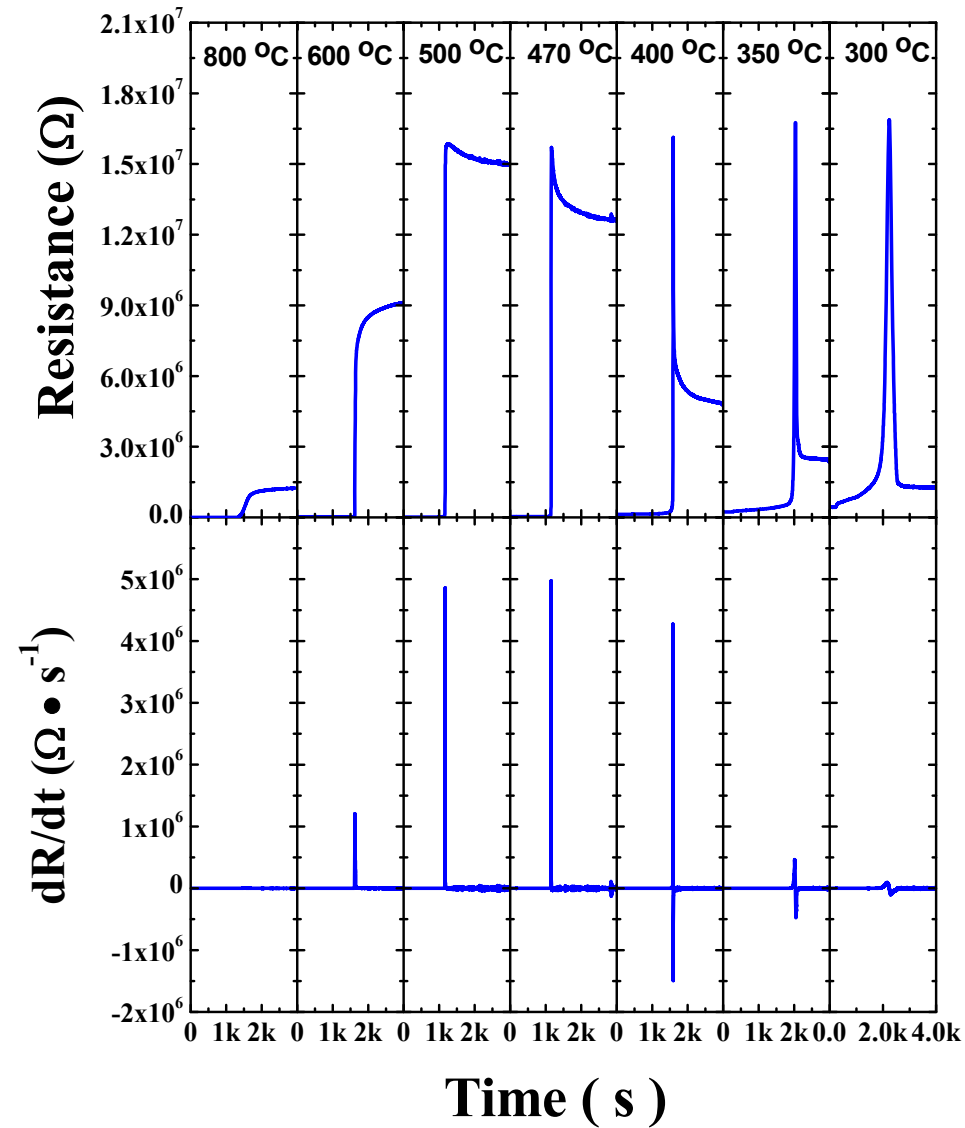

# PBCO Film Oxidation Property :

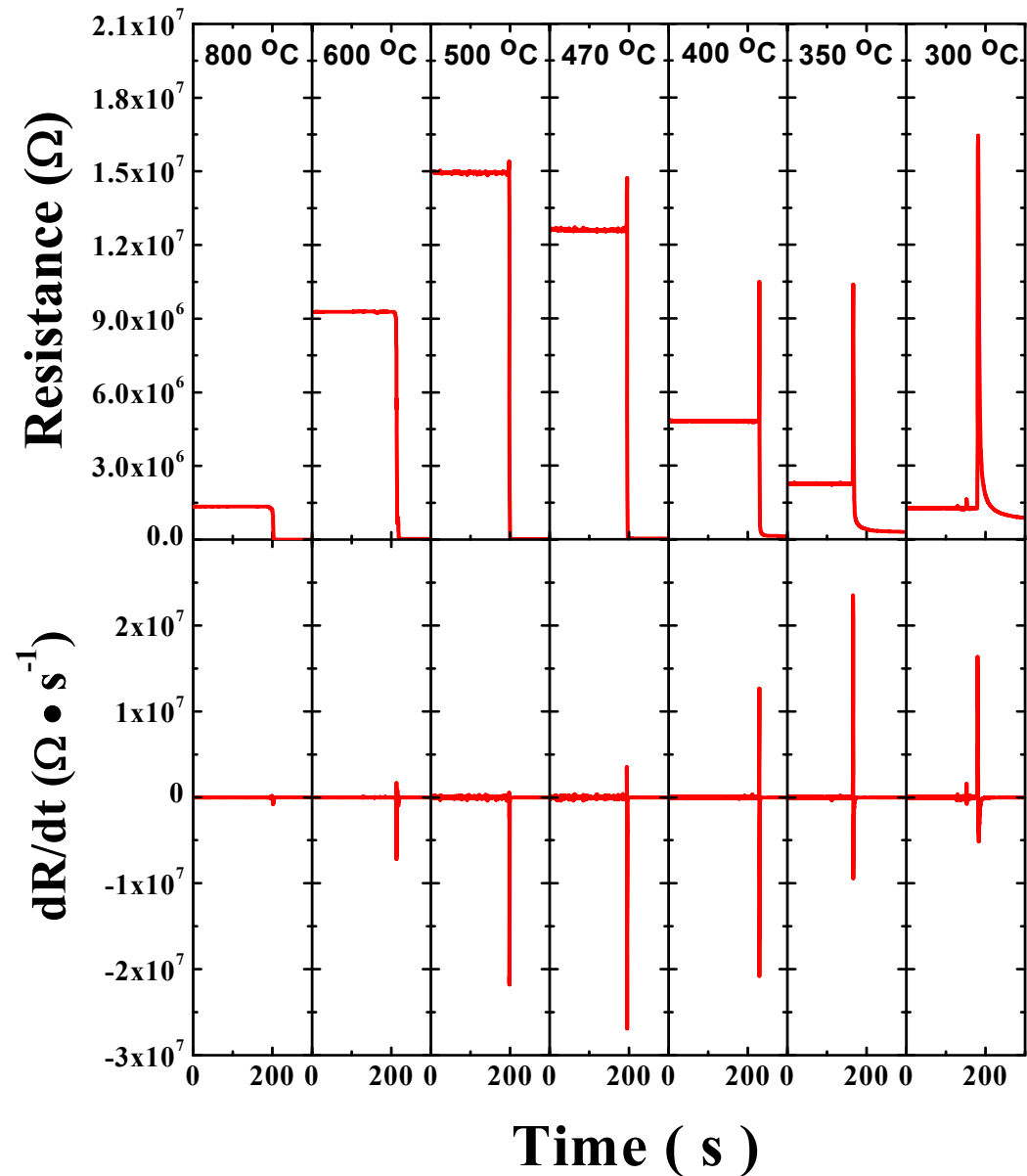



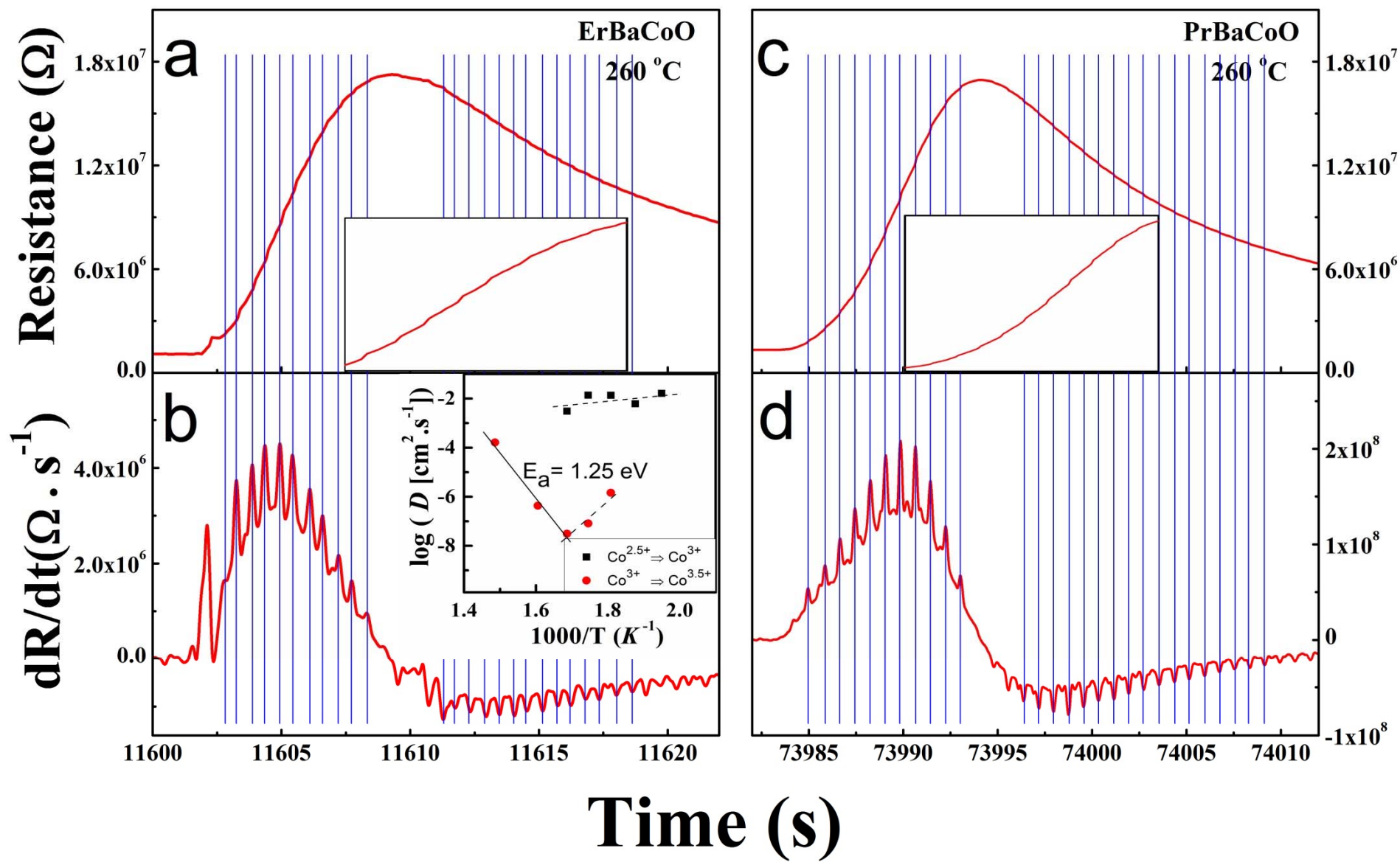

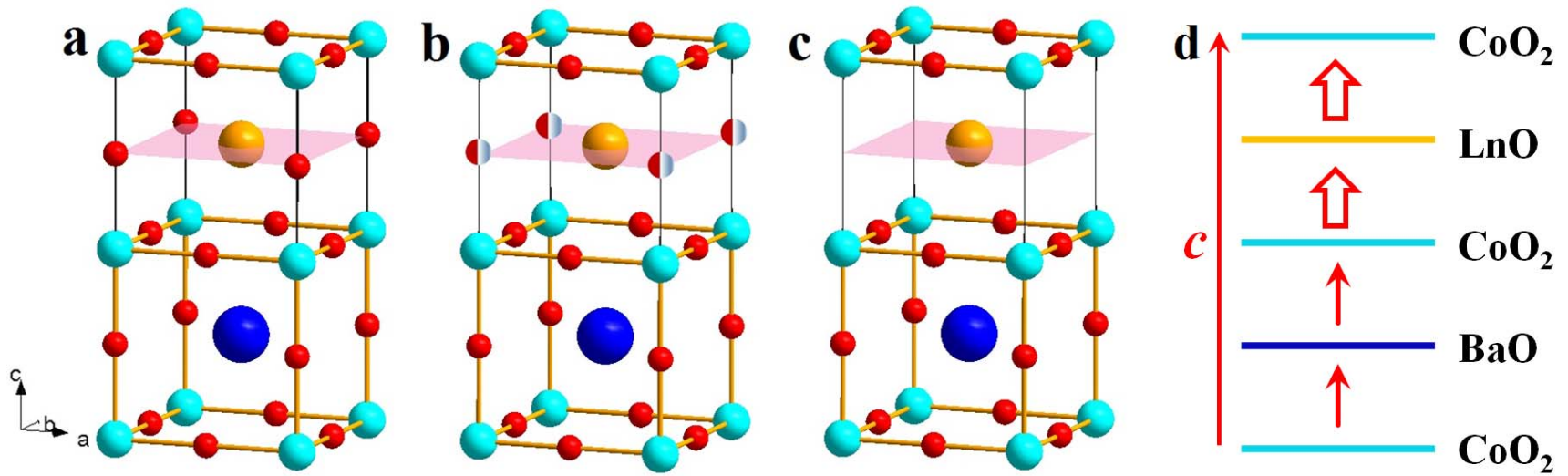

Comparison of the diffusion rates:  $D(\text{H}) > D(\text{a-Ag}_{2+d}\text{S})$  or  $D(\text{a-Ag}_2\text{Te})$ !

## Model for diffusion of carriers

$$\frac{c(x, t) - c_1}{c_2 - c_1} = 1 - \sum_{i=0}^{\infty} \frac{4(-1)^i}{\pi(2i+1)} \cos\left[\pi(2i+1)\frac{x}{L}\right] \exp\left[-\pi^2(2i+1)^2 \frac{Dt}{L^2}\right]$$

$$\frac{\sigma_m - \sigma_1}{\sigma_2 - \sigma_1} = 1 - \frac{8}{\pi^2} \sum_{i=0}^{\infty} \frac{1}{(2i+1)^2} \exp\left[-(2i+1)^2 \frac{t}{\tau}\right]$$

$$\tau = \frac{L^2}{\pi^2 D}$$

$$\frac{\sigma_m - \sigma_1}{\sigma_2 - \sigma_1} \approx 4\pi^{-3/2} \sqrt{\frac{t}{\tau}}$$

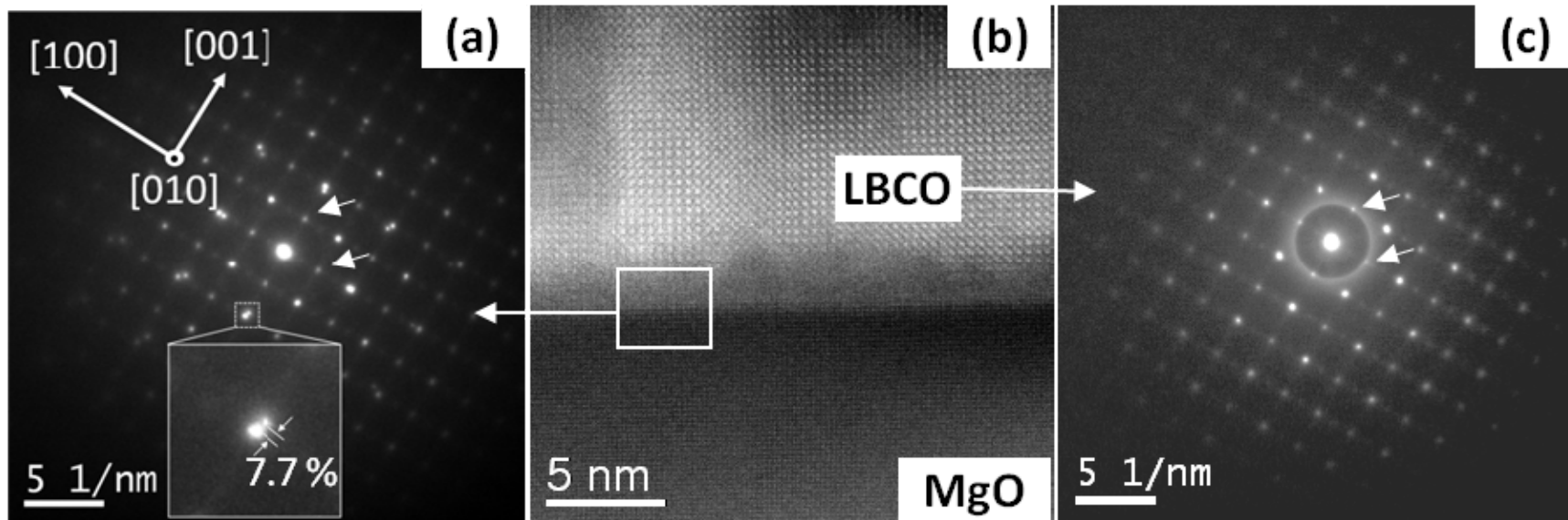

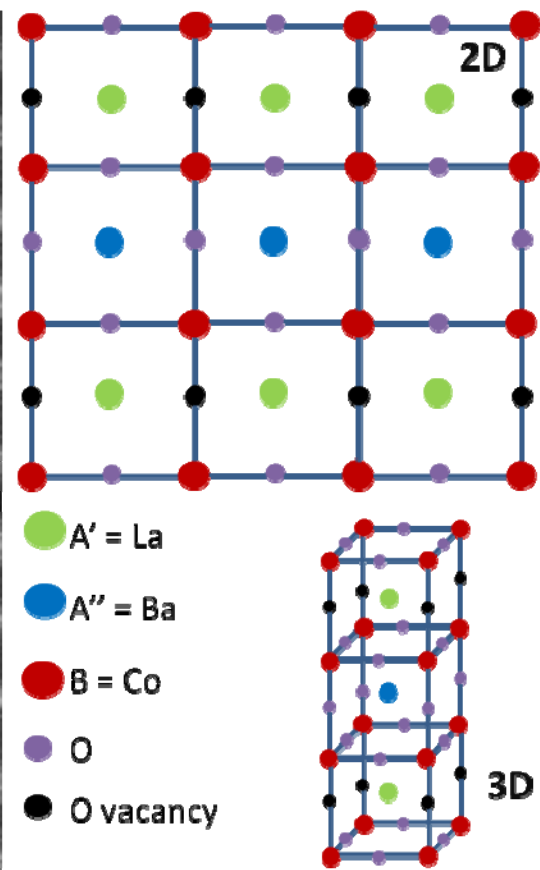
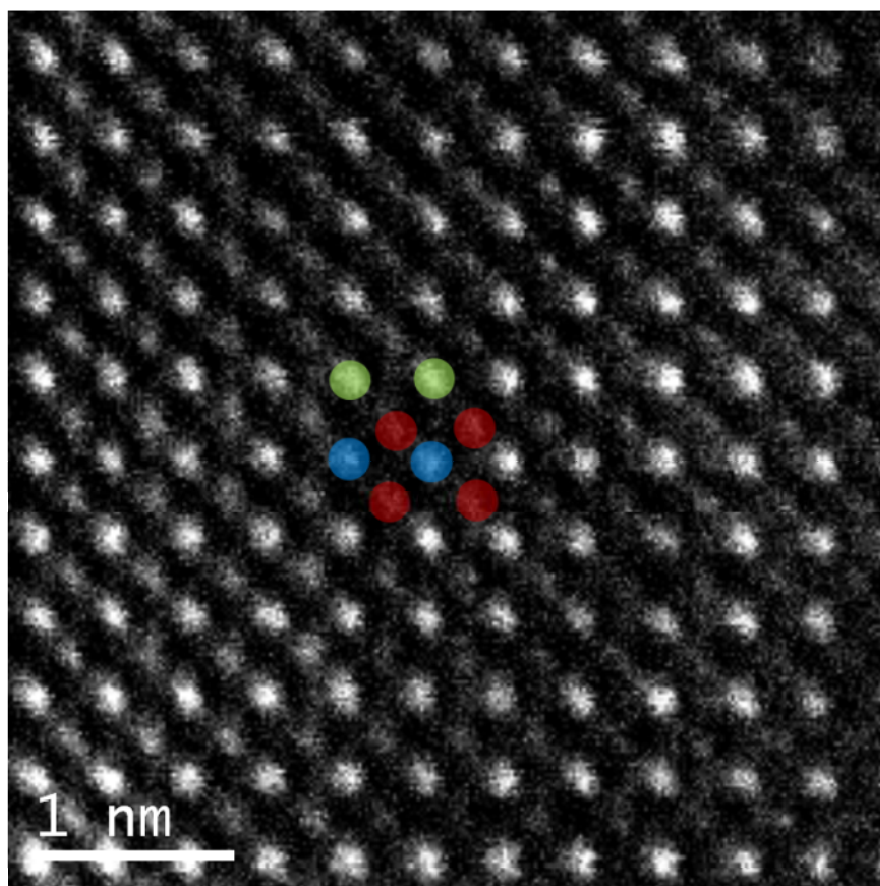

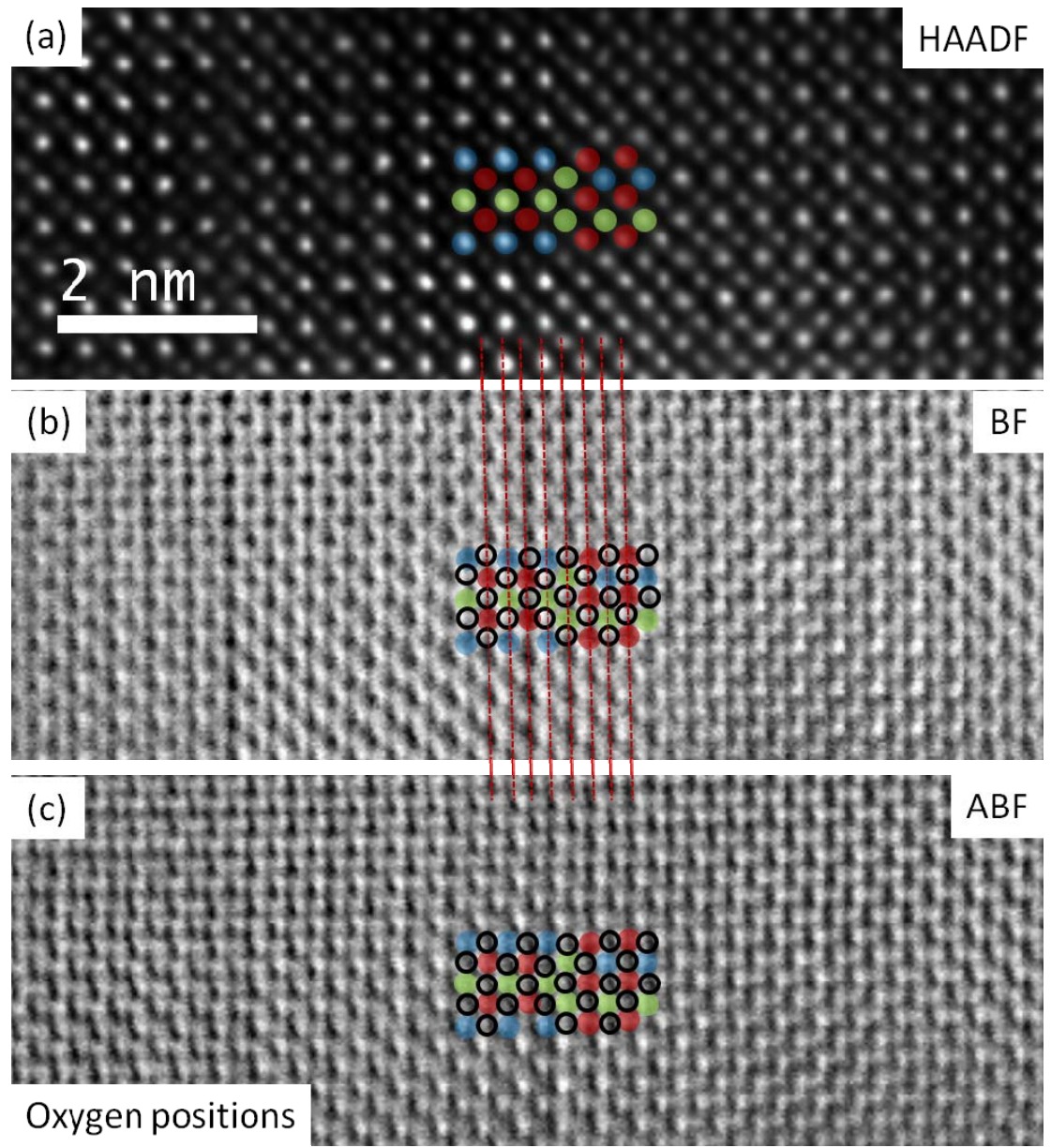

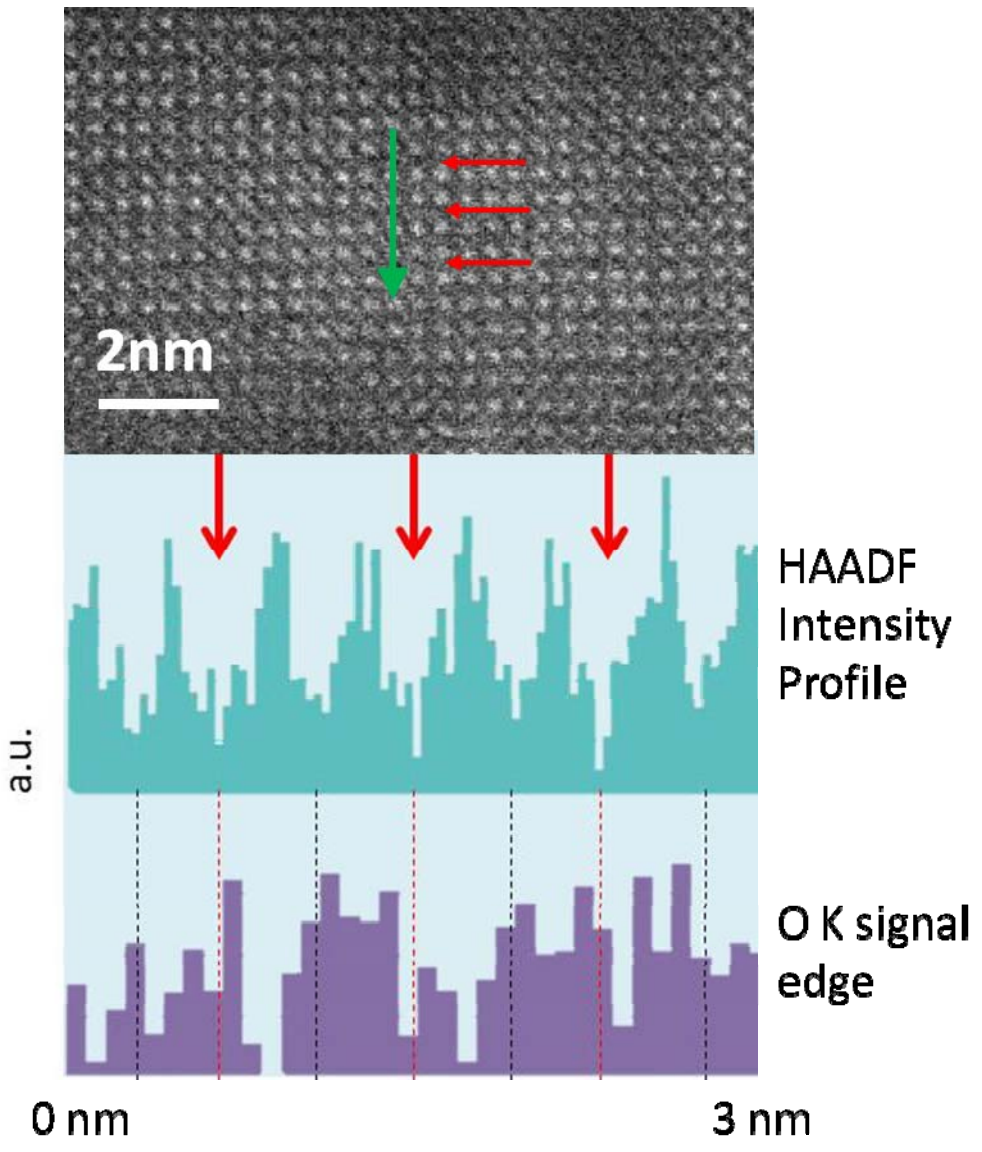

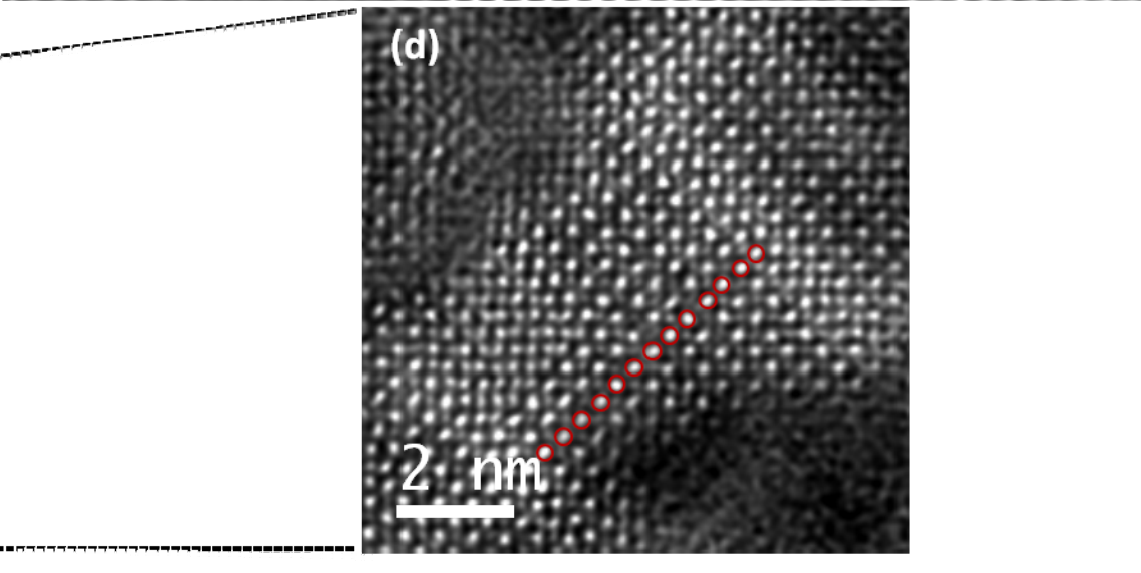
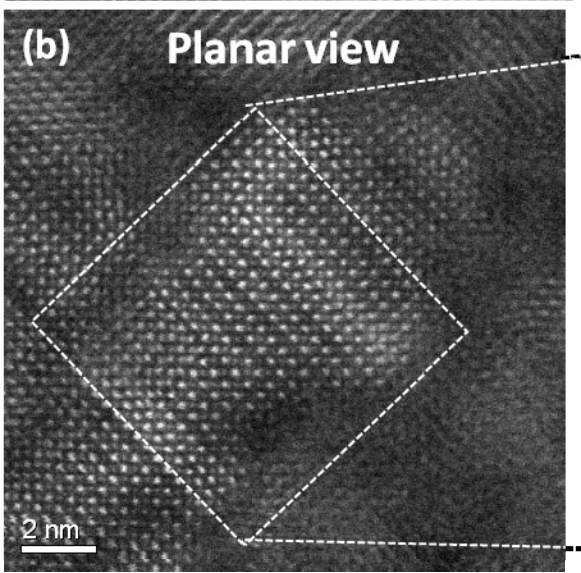
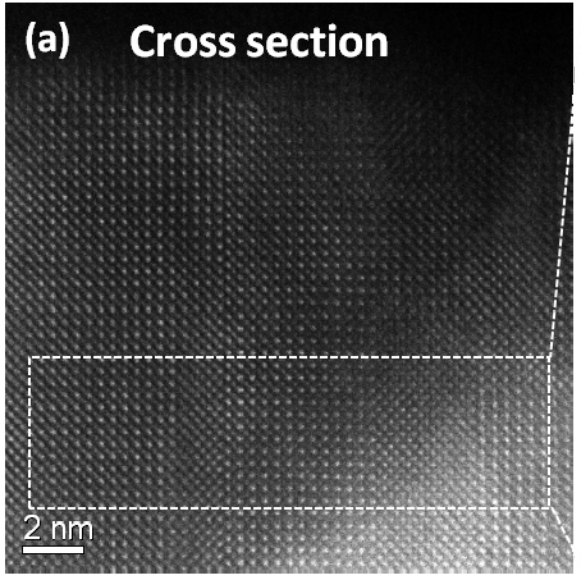



*d*-spacing 0.39 nm

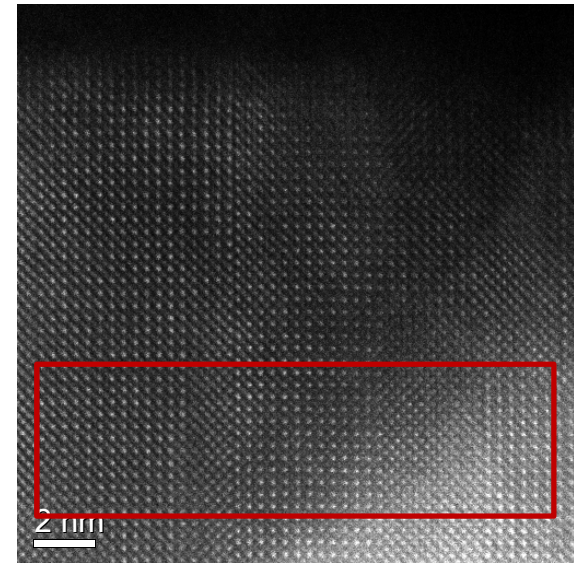
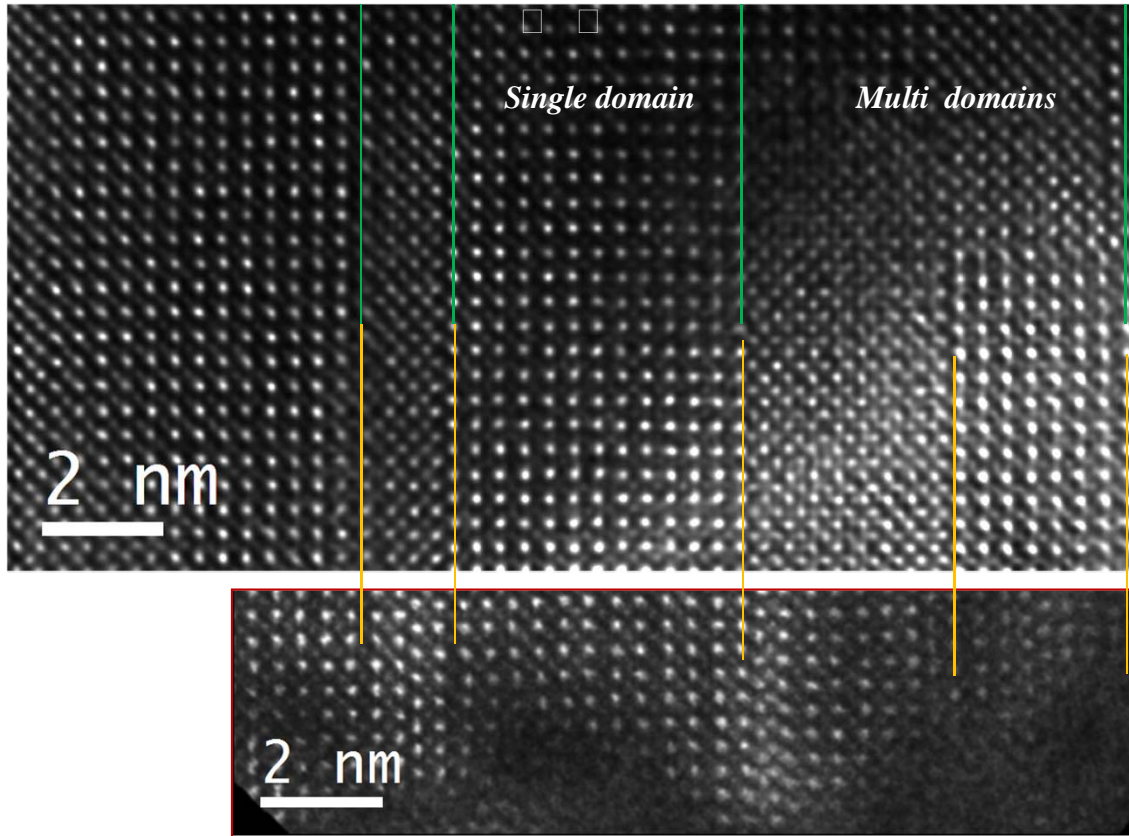

**Cross section**

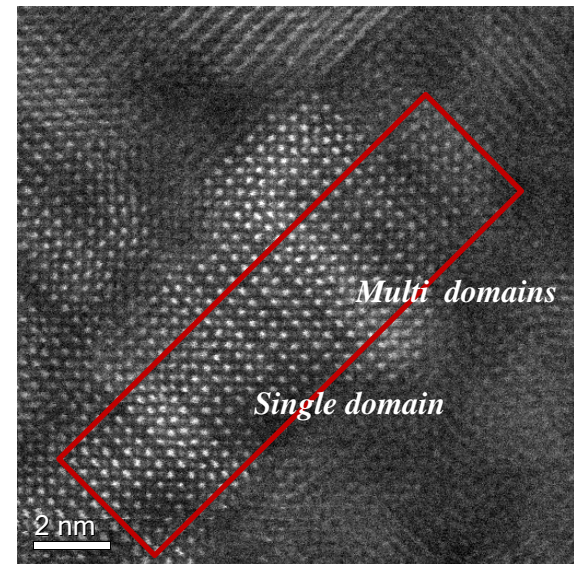

**Planar view**

# Future Research

- Continually study physical properties of LnBCO thin films and related materials at various chemical environments (gases, pressures, temperatures, etc.)
- Design and characterize the full scale (low & high temperature) chemical sensors, not only qualitatively but also quantitatively
- Explore novel materials for the development of new sensors and transducers (temperature, pressure, infra, etc.)
- Fundamentally understand the sensing mechanisms

# Tunable interconnectivity of mesostructured cobalt oxide materials for sensing applications

- The sensor resistance change of the mesostructured cobalt oxide at different template temperatures.

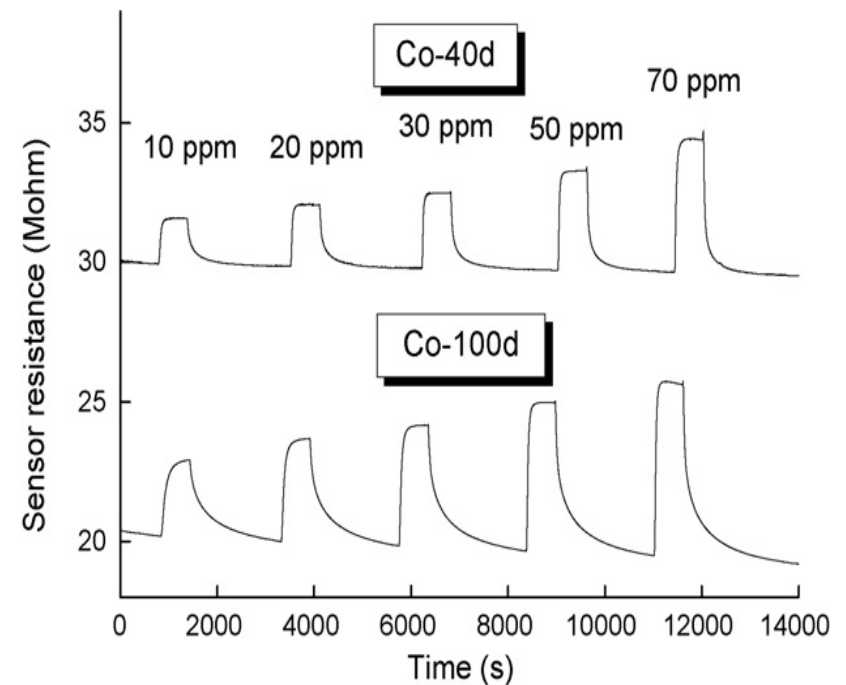

# Publications – published/revised

**US Patent:** C. L. Chen and J. Liu, “**US61/351,576:** Highly Epitaxial Thin Films for High Temperature/Highly Sensitive Chemical Sensors for Critical and Reducing Environment”.

1. W. Donner, C. L. Chen, M. Liu, A. J. Jacobson, Y.-L. Lee, M. Gadre, and D. Morgan, “Epitaxial Strain-Induced Chemical Ordering in  $\text{La}_{0.5}\text{Sr}_{0.5}\text{CoO}_{3-d}$  Films on  $\text{SrTiO}_3$ ”, ***Chem. Mat.***, **23** (2011) 984
2. Jian Liu, Gregory Collins, Ming Liu, Chonglin Chen,\* Jie He, Jiechao Jiang, and Efstathios I. Meletis, “Ultrafast Oxygen Exchange Kinetics on Highly Epitaxial  $\text{PrBaCo}_2\text{O}_{5+d}$  Thin Films”, ***Appl. Phys. Lett.***, **100** (2012) 193903.
3. Chunrui Ma, Ming Liu, Gregory Collins, Jian Liu, Chonglin Chen,\* Jie He, Jiechao Jiang, E. I. Meletis : “Thickness Effects on Magnetic and Electrical Transport Properties of Highly Epitaxial  $\text{LaBaCo}_2\text{O}_{5.5+\delta}$  Thin Films on MgO Substrates”, ***Appl. Phys. Lett.*** **101** (2012) 021601
4. M. Liu, C. R. Ma, J. Liu, G. Collins, Y. M. Zhang, C. L. Chen,\* J. He, J. C. Jiang, E.I. Meletis, Y. Lin, Li Sun, A. J. Jacobson, and Q. Y. Zhang, “Magnetic properties and anomalous transport phenomena in highly epitaxial double perovskite nano-ordering  $(\text{LaBa})\text{Co}_2\text{O}_{5.5+d}$  thin films on (001) MgO”, ***Applied Materials & Interface***, **4** (2012) 5524-5528
5. Jian Liu, Gregory Collins, Ming Liu, and Chonglin Chen,\* “Superfast Oxygen Exchange Kinetics on Highly Epitaxial  $\text{LaBaCo}_2\text{O}_{5+d}$  Thin Films for Intermediate Temperature Solid Oxide Fuel Cells”, ***APL Mat*** (in press)
6. Chunrui Ma, Ming Liu, Gregory Collins, Haibing Wang, Shanyong Bao, Xing Xu, , Erik Enriquez, **Chonglin Chen**,\* Yuan Lin, and Myung-Hwan Whangbo, “Magnetic and Electrical Transport Properties of Highly Epitaxial  $\text{LaBaCo}_2\text{O}_{5.5+\delta}$  Thin Films on Vicinal (001)  $\text{SrTiO}_3$  Surfaces”, ***Applied Materials & Interface*** **5** (2013) 451

# Publications – papers submitted

1. Shanyong Bao, Chunrui Ma, Garry Chen, Xing Xu, Erik Enriquez, Chonglin Chen,\* Yamei Zhang, Jerry L. Bettis, Jr., Myung-Hwan Whangbo, Chuang Dong, and Qingyu Zhang, “Ultrafast Chemical Exchange Dynamics with Layer-by-Layer Oxygen Vacancy-Exchange Diffusion in Cobalt Double-Perovskite Thin Films”, *Angew. Chem. Int. Ed.*, (under review).
2. H. B. Wang, S. Y. Bao, J. Liu, G. Collins, C. R. Ma, M. Liu, C. L. Chen,\* C. Dong, and M.-H. Whangbo, “Superfast Oxidation/Redox Chemical Dynamics on Highly Epitaxial LaBaCo<sub>2</sub>O<sub>5+δ</sub> Thin Films”, *Scientific Reports* (under review).
3. Q. Zou, G. Q. Wang, H. L. Lu, T. Z. Yang, H. M. Guo, H. J. Gao, M. Liu, C. R. Ma, H. B. Wang, X. Xu, and C. L. Chen, “Tunable Anisotropic Transport Properties of Highly Epitaxial LaBaCo<sub>2</sub>O<sub>6</sub> thin film on Stepped SrTiO<sub>3</sub> Substrates”, *APL Mat.*
4. G. Collins, J. Liu, C. R. Ma, H. B. Wang, C. L. Chen,\* “Interface Engineered Heterostructures Electrolyte for Novel Low Temperature Thin Film Solid Oxide Fuel Cells”, *Adv. Energy. Mat.*
5. C. R. Ma, M. Liu, J. Liu, G. Collins, Y. M. Zhang, H. B. Wang, C. L. Chen,\* Y. Lin, J. He, J. C. Jiang, E. I. Meletis, “Interface Strain Induced Anomalous Electronic Transport Behavior in Highly Epitaxial LaBaCo<sub>2</sub>O<sub>5.5+d</sub> Films”, *Chem Mat.*
6. M. Liu, C. R. Ma, E. Enriquez, H. B. Wang, C. L. Chen, Y. Lin, “Physical Properties of Highly Mixed Conductive LaBaCo<sub>2</sub>O<sub>5.5+d</sub> Thin Films directly Integrated on Si (100)”, *Materials Letters*
7. Chunrui Ma, Ming Liu, Gregory Collins, Haibin Wang, Shanyong Bao, Xing Xu, Erik Enriquez, Chonglin Chen\*, and Y. Lin, “Anisotropic Strain Induced Anomalous Metal-Insulation Transition in on Highly Epitaxial LaBaCo<sub>2</sub>O<sub>5.5+δ</sub> Thin Films on (110) NdGaO<sub>3</sub>”, *Nature Physics* (to be submitted)
8. Fransisco Ruiz-Zepeda, Chunrui Ma, Daniel B. Uribe, J. Cantu-Valle, Haibing Wang, Xing Xu, Arturo Ponce, Miguel Yacaman\* and C. L. Chen\*, “Nanodomain Induced Anomalous Magnetic Electronic Transport Properties of LaBaCo<sub>2</sub>O<sub>5.5+δ</sub> Epitxial Films”, *Chem Mat* (to be submitted)

**Several other manuscripts** are preparing for publication

# Summary

- Mixed ionic/electronic conductive double perovskite  $\text{LaBaCo}_2\text{O}_{5.5}$  thin films have been successfully grown on various substrates for full scale chemical sensors.
- Superfast chemical dynamic behavior was found from the symmetric cell structures.
- A new oxygen vacancy exchange diffusion mechanism was discovered from the cobaltate systems.
- Various new/interesting physical phenomena have been found and achieved in the LBCO materials.
- More experimental and theoretical works are needed to understand the superfast chemical oxidation/redox dynamics and to explore the interface physics.

*Thank you very much  
for your attention!*





# Tunable interconnectivity of mesostructured cobalt oxide materials for sensing applications

- The sensor resistance change of the mesostructured cobalt oxide at different template temperatures.

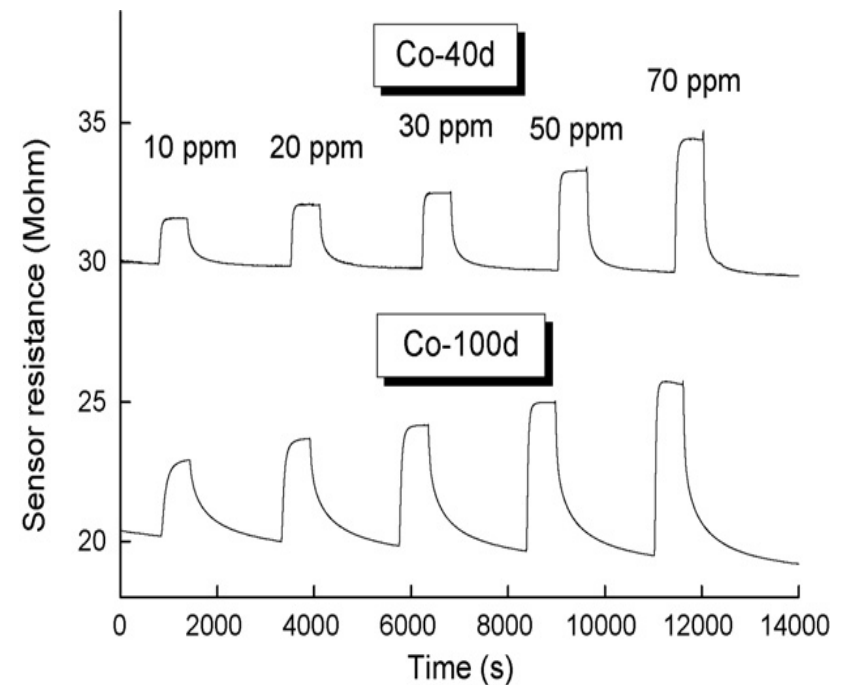

# Optical CO Gas Sensor Using a Cobalt Oxide Thin Film Prepared by Pulsed Laser Deposition under Various Argon Pressures

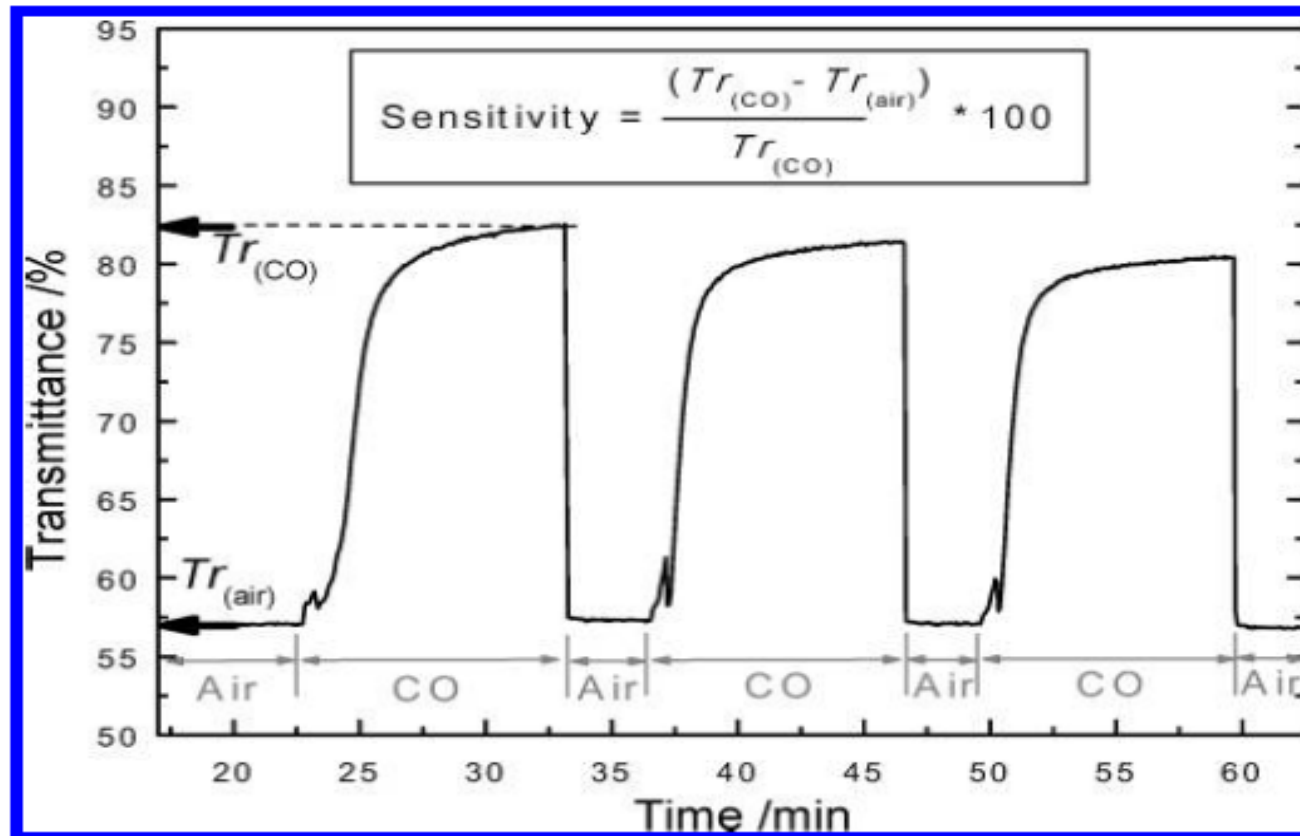

**Figure 3.** Transmittance change of a cobalt oxide film prepared at 133 Pa of Ar. The transmittance of the film at 625 nm was monitored in dry air and 200 ppm of CO gas at 350 °C. Sensitivity is defined as  $(Tr_{(CO)} - Tr_{(air)})/Tr_{(CO)} \times 100$ , where  $Tr_{(CO)}$  and  $Tr_{(air)}$  are transmittance in CO gas and dry air, respectively, at 350 °C.

## Hierarchically Structured Cobalt Oxide (Co<sub>3</sub>O<sub>4</sub>): The Morphology Control and Its Potential in Sensors

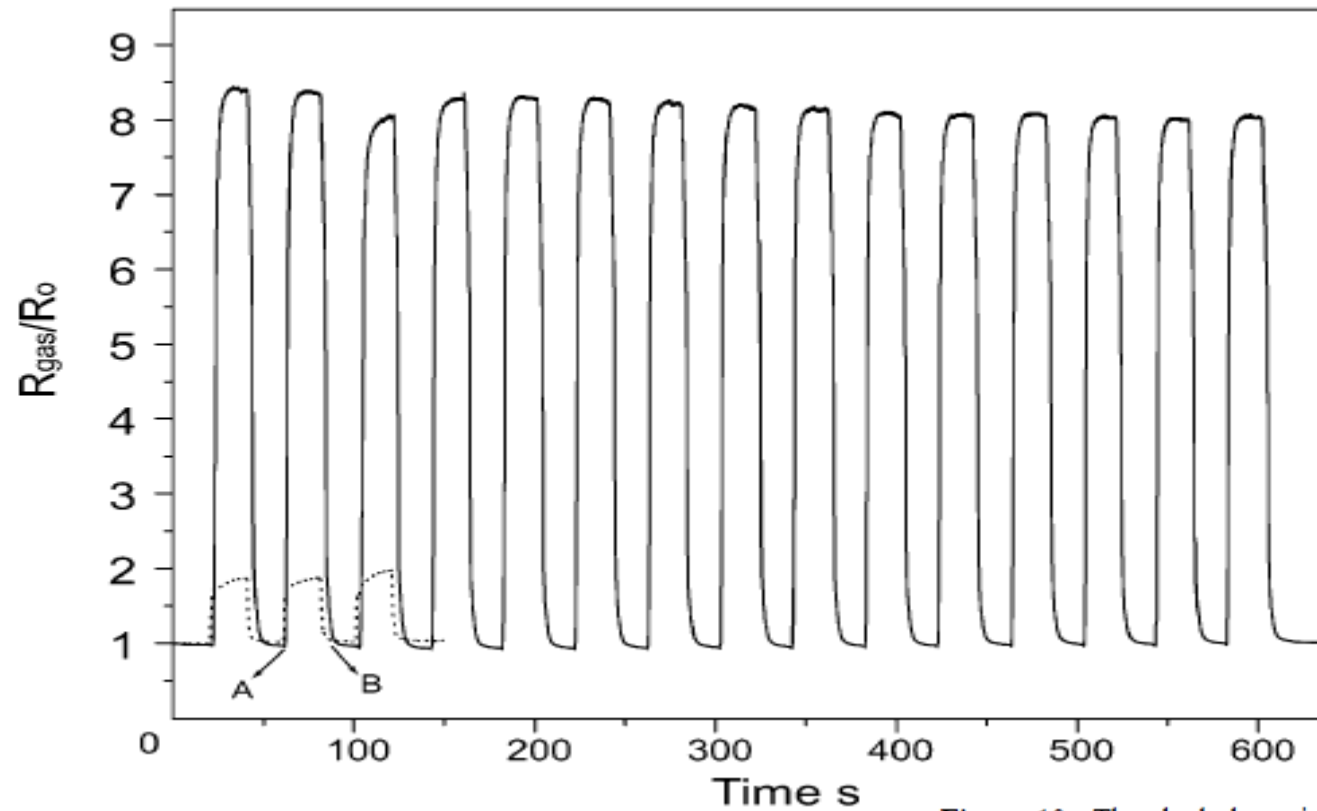

**Figure 10.** The alcohol sensing curve in a Co<sub>3</sub>O<sub>4</sub>-based sensor at 300 °C. The solid line is the response to 50 ppm alcohol and the dash line is to 1000 ppm CO, showing the selectivity of the sensor. The sensor is exposed to alcohol vapor or CO at A and for 20 s, then it is switched to dry air at B. The gas sensitivity is defined as the resistance ratio of  $R_{\text{gas}}$  to  $R_0$ , where  $R_{\text{gas}}$  and  $R_0$  are the electrical resistance for the sensor in alcohol or CO and in air, respectively.